

**NATIONAL TRANSPORT COMMISSION
&
ROADS & TRAFFIC AUTHORITY NSW**

LOAD RESTRAINT GUIDE

**Guidelines and Performance Standards
for the Safe Carriage of Loads on
Road Vehicles**

**SECOND EDITION
2004**

ISBN 0 7313 0134 X

This work is copyright. Apart from any use as permitted under the Copyright Act 1968, no part may be reproduced by any process without prior written permission from the National Transport Commission with the exception that it may be used for the purpose of training provided an acknowledgment of the source is made.



“Imagine being in my driver’s seat”

That’s me in the driver’s seat. My mother and father were in the back seats. The steel beam slid off the truck and went through the rear window and windscreen of my car.

I didn’t leave home expecting to have an accident. I doubt that the driver of the truck had planned to have an accident that day.

My experience shows that without warning, an accident can happen at a time when you least expect it. My parents and I are lucky to be alive.

I commend this guide to everyone as it explains why loads move and gives advice on how to restrain loads properly. It provides some technical information and explains items that make good sense. It’s not smart to drive with an unsecured load.

The security of your load, your life and the life of others relies on proper load restraint practices.

If you have any doubts about spending the time to read this guide and to restrain loads properly, imagine being in my driver’s seat.

A handwritten signature in black ink, appearing to read "Brad Shields".

Brad Shields

ACKNOWLEDGMENTS

The National Transport Commission (NTC) wishes to acknowledge the key role of the Roads & Traffic Authority NSW (RTA) in the preparation of this edition of the Load Restraint Guide.

Acknowledgment is also made of:

- the valuable assistance of the Load Restraint Guide Steering Committee comprising representatives from National Road Transport Commission, Roads & Traffic Authority NSW, Queensland Transport, Australian Trucking Association and the Transport Workers Union of Australia;
- the contributions of the many organisations and individuals who attended the load restraint meetings in Sydney, Melbourne, Adelaide and Perth and those who provided written information during the public comment period;
- the permission given by the Association of German Engineers for use of material contained in Directives VDI 2700, VDI 2701 and VDI 2702;
- the permission given by the Ministry of Transport, New Zealand, for use of material contained in the 'Truck Loading Code - Code of Practice for the safety of loads on heavy vehicles'.
- the document is based on the Load Restraint Guide 1994 and was developed by: Peter Goudie of the Roads & Traffic Authority and Richard Larsen of Loadsafes Australia Pty Ltd as a consultant for the project.



INTRODUCTION

The safe loading of vehicles is vitally important in preventing injury to people and damage to property. There are economic benefits to all if the load arrives at its destination intact and without damage.

This guide provides drivers, owners, operators, freight consignors, vehicle manufacturers, equipment manufacturers and suppliers with the basic safety principles that should be followed to ensure the safe carriage of loads.

The information is based on proven principles and the ability of load restraint equipment to apply the necessary restraint forces. It takes into account the performance of vehicles and towed trailers.

The guide is in two parts. Part 1 is for Drivers and Operators and Part 2 is intended for Engineers and Designers although it may be of interest to other readers. It contains greater technical detail and information on how to test and certify a load restraint system. The pages of Part 1 have a blue border and Part 2 a red border. An Appendix and a Glossary of Terms and other information is at the back. The borders on these pages are coloured yellow.

This guide and other information can be found on the Internet Web Site of the National Transport Commission, www.ntc.gov.au

Suggested improvements or additions are welcomed and should be sent to:

National Transport Commission
Level 15, 628 Bourke Street
MELBOURNE VIC 3000 AUSTRALIA

The Performance Standards in Section F1 are referred to in the national Road Transport Reform (Mass and Loading) Regulations 1995. These regulations have been approved by the Australian Transport Council for adoption by the States and Territories since 1995. Comparable requirements apply in all States and Territories and readers are advised to check the relevant legislation.

In addition, it must be remembered that the common law imposes liability for negligent acts that cause injury or damage to others and there are other legal requirements that impose a duty of care in the workplace.

SCOPE

- 1** Loads must be restrained to meet the Performance Standards of Section F1. The remaining contents of this guide are intended to be treated as recommended practice only, except where 'must' is used indicating that the design meets an Australian Standard or similar recognised standard, a manufacturer's standard or the load restraint system described meets the Performance Standards.
- 2** The principles described in this guide apply to loads of all sizes and types.
- 3** Performance Standards apply to all vehicles. However in situations where extremely large loads have been permitted to move only when the road is closed to other road users, relaxation of one or more of the Performance Standards may be accepted provided the operators of the vehicles moving the load and the escorting personnel are not put at risk.
- 4** Alternative load restraint methods to those referred to in this guide may be used provided they have been shown to meet the Performance Standards outlined in Section F1.
- 5** Requirements for the safe transport of dangerous goods as packages, unit loads or bulk loads are covered by this guide, but without reference to their 'dangerous goods' characteristics. References to the specialised requirements of the 'Australian Code for the Transport of Dangerous Goods by Road and Rail' (see Section J.3) are included where applicable.

**The security of your load,
your life and the life of others
relies on proper
load restraint**

EXPLANATION OF TERMS

This guide contains some technical terms and details. A Glossary is contained in Section J and the following is a brief explanation of a few of the major terms:

Mass: Mass is a measure of the amount of matter in an object.
(In this guide, mass is referred to in kilograms (kg) or tonnes (t).)

Force: Force is applied to a mass to move it.
(Force is normally measured in Newtons (N) or kilo Newtons (kN). However, in this guide, force is referred to in kilograms force (kgf) or tonnes force.)

Weight: Weight is the force exerted by gravity on a mass.
(1 kilogram force is the weight of a mass of 1 kilogram.)

'g': The acceleration due to gravity is called 'g'. It is equal to 9.81 metres/sec/sec.

Performance Standards: A way of specifying the minimum amount of load restraint required, measured in terms of 'g' or the weight of the load.

Tie-down: Tie-down is a form of load restraint where the load is restrained by friction. It is sometimes called indirect restraint.

Direct Restraint: Direct restraint is a form of load restraint where the load is restrained by containing, blocking or attaching.

Friction: Friction is the resistance of one surface sliding across another.

Coefficient of friction (μ): The coefficient of friction is a measure of the friction between two surfaces in contact. It is equal to the amount of force required to make one surface slide relative to the other, divided by the force that presses them together.

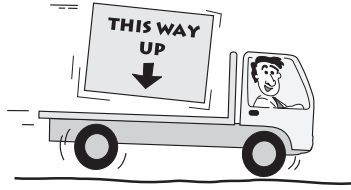
Lashing: A lashing is a restraint device such as a rope, chain or strap and can include other components such as tensioners, hooks, etc.

Pre-tension: Pre-tension is the force in a lashing resulting from initial tightening by the operator.

Dunnage: Dunnage is packing used to separate loads (typically, a length of timber).

Unitised load: A unitised load is a number of separate items bound together to form a single item of load.

DID YOU KNOW ?



- A load that is restrained so it doesn't shift is required to withstand forces of at least:
 - 80% of its weight in the forward direction;
 - 50% of its weight sideways and rearwards, and
 - an additional 20% of its weight vertically.
- Some industry practices have been tested and the forward restraint found to be only half that required.
- There is often a greater chance of losing a load when braking at low speed than at high speed as it is easier for the brakes to grab at low speed.
- Ropes are extremely ineffective for restraining loads.
- Even though a rope might feel tight, the amount of tension in it is very low.
- The tension in a webbing strap is generally about 5 to 10 times more than a rope.
- Short chains are difficult to tighten properly with a 'dog', because they won't stretch as much as a long chain, to allow the handle to be pulled down. Turnbuckles are better.
- If a load is properly restrained, on a stationary tipping truck or trailer, it will not dislodge, even when the deck is fully tilted.
- Just because a load has been carried in a particular way for many years does not mean it is properly restrained.
- A 'curtain-side' cannot restrain a load properly unless it is part of a certified load restraint system.
- The weight of the load alone cannot provide enough friction to restrain it during normal driving. Additional restraint must be used.
- A heavy load is just as likely to fall off as a light load. The same 'g' forces are acting on both.
- If a load falls off a vehicle travelling at 100 km/h and is hit by a vehicle travelling in the opposite direction at 100 km/h, it has the same impact as the load travelling at 200 km/h and hitting the vehicle when it is stationary.
- Most headboards and loading racks are not strong enough to fully restrain heavy loads.

-
- Any load that is properly restrained will not come off a vehicle in normal driving including the most severe braking, swerving and cornering.
 - Most load restraint accidents occur at low speed in city areas and often only after a short distance. The same amount of restraint must be used for every journey.
 - When the load settles, the lashings loosen and cause a huge reduction in tension. The tension in the lashings should be checked soon after moving off and then regularly during the journey.
 - Checkerplate steel decks are just as slippery as smooth flat steel decks.
 - Loading directly onto slippery steel decks, roof racks or A-frames should be avoided. Use wood or rubber to improve the grip.
 - The most cost-effective method to tie down many loads is to put a tough rubber load mat underneath the load. Rubber load mat can more than halve the number of lashings needed.
 - Conveyor belting may have only half the grip of rubber load mat. Its surface is designed to resist wear and is therefore more slippery especially when wet. Rubber load mat or timber dunnage is better.
 - Low friction is 'high risk'.
 - In some cases, if the load and deck are both slippery, it could be necessary to use four 50 mm webbing straps (each 2 tonne lashing capacity) to tie down a half tonne load.
 - If you have enough tie down lashings and the load does not shift when cornering or braking, the tension in the lashings always stays the same. It does not increase even under heavy braking because the load has not moved.
 - The driver could lose control if a trailer or caravan begins to sway sideways because it is poorly loaded. Make sure the drawbar always pushes down on the towbar.
 - The headlights on some vehicles should be adjusted when they are loaded.

LOAD SAFETY IS ROAD SAFETY

If you want to find out more about how to restrain loads safely, read on ...



These photos show three important points :

- 1 No load is too small to be restrained;
- 2 The toy truck is raised off its wheels on timber to provide friction;
- 3 The angle of the webbing strap is so low that the 50 mm heavy duty ratchet can just apply enough downward force to prevent movement of the toy truck.

LOAD RESTRAINT GUIDE

CONTENTS

PART 1

SECTION A	GENERAL PRINCIPLES OF LOAD RESTRAINT	17
1	LOAD SHIFT	18
2	HOW TO CARRY A LOAD SAFELY	21
3	LOAD RESTRAINT METHODS	22
SECTION B	ARRANGING LOADS ON VEHICLES	33
1	SELECTING THE VEHICLE	35
2	POSITIONING THE LOAD	37
3	RECOGNISING UNSTABLE LOADS	43
4	USING DUNNAGE	46
5	LOADING AND UNLOADING	48
6	DOs AND DON'Ts	48
SECTION C	RESTRAINING LOADS ON VEHICLES	55
1	HOW MUCH LOAD RESTRAINT?	58
2	TIE-DOWN METHOD	60
3	DIRECT RESTRAINT METHOD	68
4	VEHICLES AND LOAD RESTRAINT EQUIPMENT	73
5	TENSIONERS	81
6	USING LOAD RESTRAINT EQUIPMENT	84
7	WEAR AND DAMAGE	91
8	DOs AND DON'Ts	92
SECTION D	DRIVING LADEN VEHICLES	105
1	VEHICLE DYNAMICS	107
2	CHECKING THE LOAD	108
3	HIGH AND WIDE LOADS	108
4	DOs AND DON'Ts	108

SECTION E	LOADS	117
1	GENERAL FREIGHT -----	119
2	PACKS AND PALLETS -----	121
3	ROLLS, REELS, COILS AND DRUMS -----	125
4	PIPES, TUBES, LOGS, RODS, BARS AND BILLETS -----	128
5	SHEETS AND FLAT LOADS -----	137
6	BALES, BAGS AND SACKS -----	138
7	CONTAINED LOADS -----	140
8	LARGE LOADS -----	145
9	VEHICLES AND MOBILE EQUIPMENT -----	152

PART 2

SECTION F	CALCULATING RESTRAINT REQUIREMENTS	185
1	PERFORMANCE STANDARDS	186
2	METHODS OF LOAD RESTRAINT	187
3	DESIGN FOR TIE-DOWN	187
4	DESIGN FOR CONTAINING OR BLOCKING	199
5	DESIGN FOR UNITISING	200
6	DESIGN FOR DIRECT ATTACHMENT	200
7	DESIGN FOR COMBINED TIE-DOWN AND DIRECT RESTRAINT	206
SECTION G	VEHICLE STRUCTURES	209
1	TIE-RAILS AND LOAD ANCHOR POINTS	211
2	WINCH TRACKS	211
3	CONTAINER TWIST LOCKS	212
4	HEADBOARDS, LOADING RACKS AND BARRIERS	212
5	SIDE GATES AND DROP SIDES	212
6	STAKES, PINS, PEGS, POSTS AND STANCHIONS	213
7	CRADLES, CHOCKS, A-FRAMES AND TRESTLES	214
8	CONTAINMENT BODIES	216
9	TANKS AND TANKERS	216
10	LATCHES, LOCKS AND HINGES	217
11	LOADING EQUIPMENT	218
12	STORAGE OF EQUIPMENT	218
13	LOAD DISTRIBUTION	218
SECTION H	LOAD RESTRAINT EQUIPMENT	223
1	SYNTHETIC ROPE	225
2	WEBBING ASSEMBLIES	226
3	CHAIN ASSEMBLIES	227
4	WIRE ROPE AND ATTACHMENTS	227
5	STRAPPING	228
6	LASHING TENSIONERS AND CONNECTORS	229
7	INTER-LAYER PACKING	229
8	DUNNAGE, BLOCKING TIMBER, CHOCKS, AIR BAGS AND TYRES	230

SECTION I	HOW TO CERTIFY A LOAD RESTRAINT SYSTEM	235
------------------	---	------------

1	WHO SHOULD DO THE DESIGN AND CHECKING? -----	236
2	SUGGESTED METHODS OF TESTING A LOAD RESTRAINT SYSTEM -----	236
3	REPORTING -----	238
4	RECORDS -----	239
5	OTHER -----	239
6	LOADING AND LOAD RESTRAINT PROCEDURES -----	239

SECTION J	APPENDICES	245
------------------	-------------------	------------

1	GLOSSARY -----	246
2	LIST OF RELEVANT STANDARDS -----	250
3	LIST OF RELEVANT PUBLICATIONS -----	251
4	COMMONWEALTH, STATE AND TERRITORY TRANSPORT REGULATORY AUTHORITIES -----	253
5	COMPETENT AUTHORITIES FOR ROAD TRANSPORT OF DANGEROUS GOODS -----	254

SECTION K	TABLES	257
------------------	---------------	------------

1	C.3 MAXIMUM WEIGHT RESTRAINED BY ONE LASHING -----	258
2	C.4 TYPICAL LASHING CAPACITY -----	259
3	F.2 AVERAGE PRE-TENSION -----	260
4	F.3 MAXIMUM WEIGHT EACH 10 OR 12 MM ROPE CAN RESTRAIN (USING SINGLE HITCH) -----	261
5	F.4 MAXIMUM WEIGHT EACH 10 OR 12 MM ROPE CAN RESTRAIN (USING DOUBLE HITCH) -----	262
6	F.5 MAXIMUM WEIGHT EACH 50 MM WEBBING STRAP CAN RESTRAIN -----	263
7	F.6 MAXIMUM WEIGHT EACH 8 MM CHAIN CAN RESTRAIN -----	264
8	F.7 MINIMUM LASHING CAPACITY - DIRECT RESTRAINT FORWARDS (0.8W) USING TWO CHAINS -----	265
9	F.8 MINIMUM LASHING CAPACITY - DIRECT RESTRAINT SIDEWAYS OR REARWARDS (0.5W) USING TWO CHAINS -----	266

Load Restraint Guide



PART 1 **for** **Drivers and Operators**



Section A - General Principles of Load Restraint



SECTION A

GENERAL PRINCIPLES OF LOAD RESTRAINT

CONTENTS	
1	LOAD SHIFT 18
2	HOW TO CARRY A LOAD SAFELY 21
2.1	Choose a Suitable Vehicle ----- 21
2.2	Position the Load Correctly ----- 21
2.3	Use Suitable Restraint Equipment ----- 21
2.4	Provide Adequate Load Restraint ----- 21
2.5	Use Appropriate Driving Methods ----- 22
3	LOAD RESTRAINT METHODS 22
3.1	Tie-down Method ----- 23
3.2	Direct Restraint Method ----- 23
3.2.1	Contained loads ----- 24
3.2.2	Blocked loads ----- 24
3.2.3	Attached loads ----- 25
3.3	Combined Tie-down and Direct Restraint Method ----- 26



Section A - General Principles of Load Restraint

This Section describes the general principles and methods of load restraint. They are based upon the general principle that:

Any load-carrying vehicle must be loaded and driven in such a way as to prevent danger to any person, or damage to any property.

1 LOAD SHIFT

When moving, a vehicle and its load are subjected to forces caused by changes of speed, direction or slope. These forces result from braking, accelerating, cornering or travelling over cambered, undulating or uneven road surfaces and air flow.

The load can shift forward when driving forward and braking, or accelerating in reverse. (see Figure A.1).

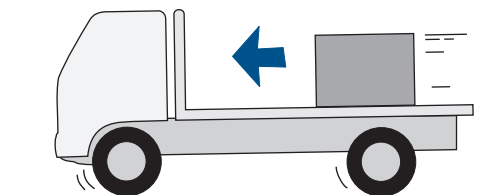


Fig. A.1

BRAKING

The load can shift rearwards when braking in reverse, or accelerating forward (see Figure A.2).

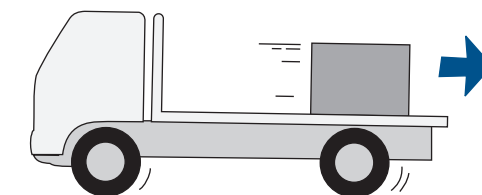


Fig. A.2

BRAKING IN REVERSE

The braking force on the load is often higher at low speed than at high speed because the brakes may grab suddenly.

The load can shift sideways when cornering. The amount of force needed to prevent the load shifting will increase as the speed increases and as the corner gets tighter (see Figure A.3).

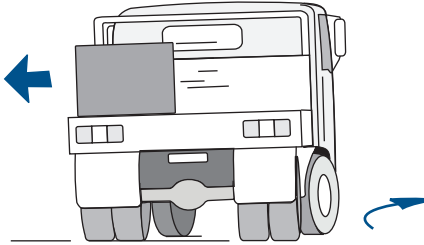


Fig. A.3

CORNERING

The force on the load when travelling over undulating or hilly roads will increase as the slope of the road increases (see Figure A.4)

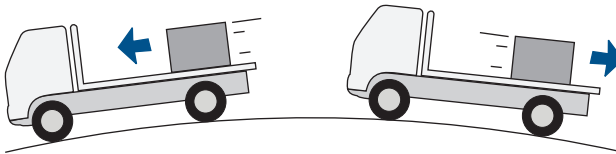


Fig. A.4

HILLS

The force on the load when travelling over cambered roads increases as the camber of the road increases (see Figure A.5).

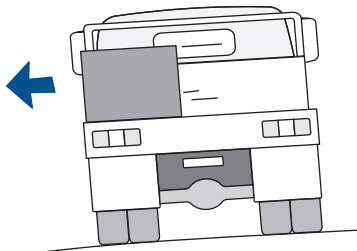


Fig. A.5

CAMBER



Section A - General Principles of Load Restraint

When a vehicle is travelling at high speed or in windy conditions, the force caused by air flow can shift a load, especially lightweight objects with large surface areas (see Figure A.6).

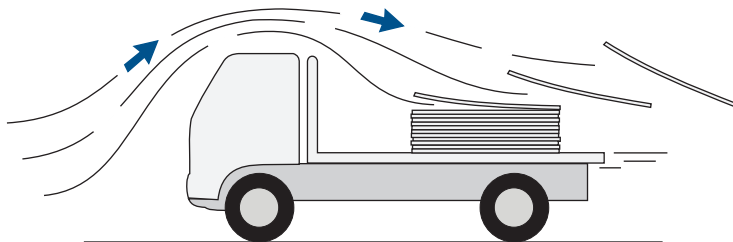


Fig. A.6

AIR FLOW

When a vehicle is travelling over rough surfaces, an unsecured load can shift or fall off the vehicle (see Figure A.7).

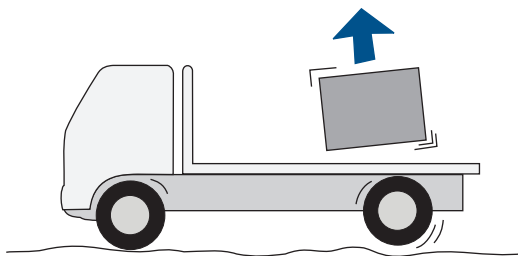


Fig. A.7

ROUGH ROADS

The weight of the load alone cannot provide enough friction to restrain it during normal driving. Additional restraint must be used.

If the load becomes dislodged from the vehicle and collides with a stationary object, the amount of damage it causes increases as its mass and the speed of the vehicle increases.

2 HOW TO CARRY A LOAD SAFELY

The following is a summary of the principles outlined in Sections B, C, D, E, F, G, and H.

2.1 Choose a Suitable Vehicle.

The vehicle must be suitable for the type and size of load (see Section B).

2.2 Position the Load Correctly.

The load must be correctly positioned on the vehicle (see Section B).

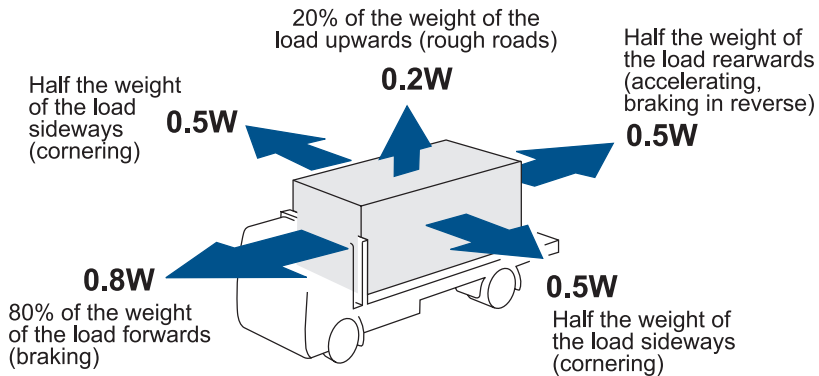
2.3 Use Suitable Restraint Equipment.

The load restraint equipment and the vehicle body and attachments must be strong enough for each type of load carried and must be in good working condition (see Sections C, G and H).

2.4 Provide Adequate Load Restraint.

Every load must be restrained to prevent unacceptable movement during all expected conditions of operation.

The load restraint system will meet the Regulation Performance Standards (see Section F), if the load doesn't shift when subjected to forces illustrated below in Figure A.8.



(W = Weight of the load)

Fig. A.8

LOAD RESTRAINT FORCES



Section A - General Principles of Load Restraint

2.5 Use Appropriate Driving Methods

If the load is correctly restrained it will not shift or fall off in all expected driving conditions, including a full braking stop.

Because a loaded vehicle might drive differently, the driver must take into account any changes in the vehicle's stability, steering and braking caused by the size, type and position of the load.

The driver should check the load and its restraint during the journey (see Section D). Loads that can settle must be checked regularly.

3 LOAD RESTRAINT METHODS

Loads can be restrained by two basic methods, either indirectly or directly. In this document, these methods are called 'Tie-down' and 'Direct Restraint' respectively.

Tie-down is when the load is prevented from moving by friction only.

Direct restraint is when the load is prevented from moving by containing, blocking or attaching it to the vehicle.

These load restraint methods are summarised below in Figure A.9, which shows restraint of forward movement of the load. These principles also apply for restraint sideways, rearwards and vertically.

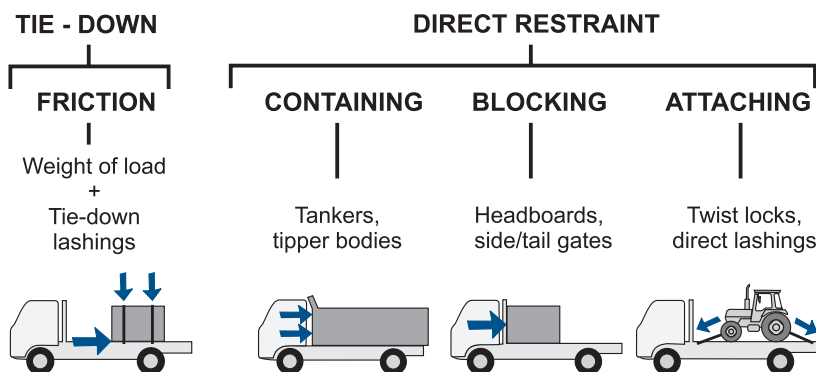


Fig. A.9

LOAD RESTRAINT METHODS (TO CONTROL FORWARD MOVEMENT)

3.1 Tie-down Method

Tie-down restraint is the most common form of load restraint and involves the use of lashings.

The load is prevented from moving by friction between the load and the vehicle.

The friction force prevents the load moving forward, rearward and sideways. The lashings are tensioned to clamp the load to the vehicle and to prevent the load from moving upwards.

The friction force comes from both the weight of the load and the clamping force of the lashings. When the surfaces are slippery, the friction forces can be very low.

Lashings that clamp the load onto the vehicle are called 'tie-down lashings' (see Figure A.10).

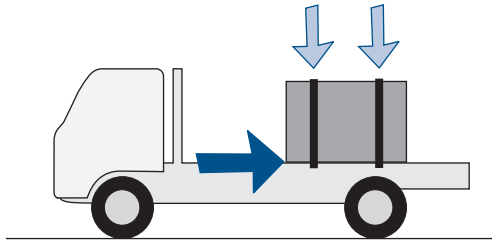


Fig. A.10 **LOAD RESTRAINED USING TIE-DOWN LASHINGS**

Friction cannot be taken into account unless the tensioned lashings provide adequate clamping of the load on the deck. Unrestrained loads, even on high friction surfaces, can bounce when travelling over uneven road surfaces and then shift during changes in speed, direction or slope.

3.2 Direct Restraint Method

A load can be directly restrained by containing, blocking or attaching without any assistance from friction.

Direct restraint by containing (see Figure A.11) or blocking (see Figure A.12) is the best method for securing loads that are difficult to tie down. Specially constructed bodies and equipment can reduce the amount of time needed to restrain loads.



Section A - General Principles of Load Restraint

3.2.1 Contained loads

Contained loads can be directly restrained without any securing devices. These include liquids in tanks, bulk solids in tanks or rigid sided bodies and mixed loads of various items in rigid sided bodies or containers (see Figure A.11). See also Section E.7, page 140.

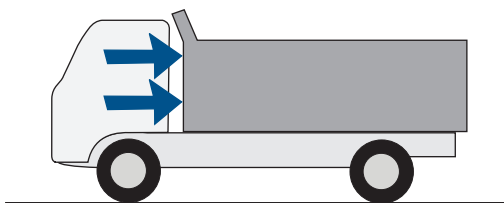


Fig. A.11

LOAD CONTAINED IN TIPPER

3.2.2 Blocked loads

Loads can be directly restrained by blocking against vehicle structures or other items of load or packing in contact with the structures. These structures include headboards (see Figure A.12), braced loading rack, drop-sides and bulkheads. The load in Figure A.12 is blocked from moving forwards by the headboard, but requires additional sideways, rearward and vertical restraint.

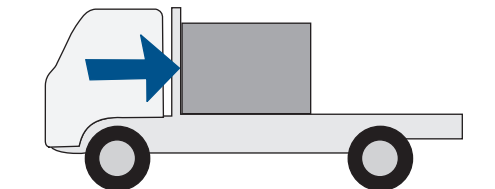


Fig. A.12

LOAD BLOCKED AGAINST HEADBOARD

Direct restraint by attaching can use lashings or mechanical locking devices (see Figures A.13 & A.14).

3.2.3 Attached loads

Attached loads can be directly restrained by lashings that provide all the necessary restraint (see Figure A.13).

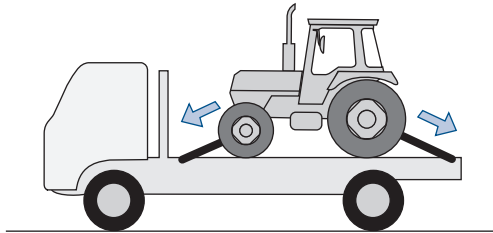


Fig. A.13 **LOAD ATTACHED USING DIRECT LASHINGS**

Attached loads can be directly restrained by mechanical locking devices that provide all the necessary restraint. Figure A.14 shows a shipping container restrained by twist locks. The twist locks do not rely on friction between the load and the deck.

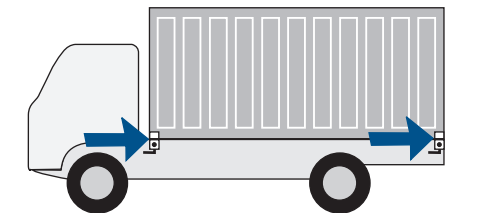


Fig. A.14 **LOAD ATTACHED USING TWIST LOCKS**



Section A - General Principles of Load Restraint

3.3 Combined Tie-down and Direct Restraint Method

Combined tie-down and direct restraint uses both friction and direct restraint.

Figure A.15 illustrates load restraint provided by:

- friction force from the weight of the load, plus
- friction force from tie-down lashings, plus
- blocking (the front part of the load is blocked by the headboard and the rear part of the load is then blocked by the front part).

The load is prevented from moving forwards by a combination of friction force from the weight of the load and the lashing tension, and also blocking against the headboard.

The load is prevented from moving rearwards and sideways only by friction.

The load is prevented from moving upwards by the lashings.

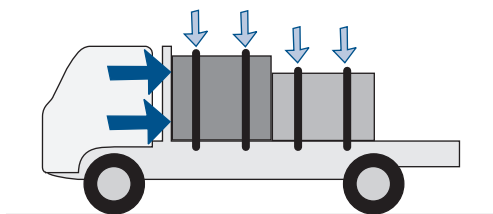


Fig. A.15

FRICION + BLOCKING

Figure A.16 illustrates load restraint provided by:

- friction force from the weight of the load, plus
- friction force from the downward force from the lashings, plus
- direct restraint from lashings that are attached to the load.

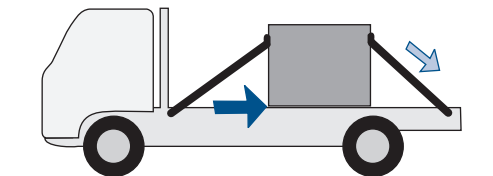


Fig. A.16

FRICION + DIRECT RESTRAINT



A tarpaulin alone cannot restrain this load of concrete blocks.



There were no lashings on this load and the plastic wrapping did not adequately hold the load together. (The enforcement officer is holding a leaning pallet of boxes on the truck while the driver is getting some restraint equipment from the toolbox).



How high can you go? Relying on hydraulics to restrain a load is a dangerous practice particularly if the load in the skips is compressible and can settle.



There aren't enough ropes to restrain all of this load of fruit and vegetables. Such loads are best restrained, packed inside gates or enclosed vehicles where they can't be damaged by ropes or straps.



Airflow could lift and dislodge this large sheet. All of the load must be properly restrained. *(Photo courtesy John Brentnall).*



The strength of the bullbar could provide greater driver safety if placed at the front of the load (see page 73 and 74).



This vehicle lost a poorly restrained lightweight roll of plastic 'bubble wrap'. An oncoming concrete agitator rolled (see below), when swerving to avoid the obstacle on the road. (Photo courtesy Mick Simpson, Wales Truck Repairs).





The pipes on both these vehicle were unrestrained and rolled from side to side during cornering.





Section A - General Principles of Load Restraint



SECTION B

ARRANGING LOADS ON VEHICLES

CONTENTS	
1	SELECTING THE VEHICLE 35
2	POSITIONING THE LOAD 37
3	RECOGNISING UNSTABLE LOADS 43
4	USING DUNNAGE 46
5	LOADING AND UNLOADING 48
6	DOs AND DON'Ts 48



Section B - Arranging Loads on Vehicles

This Section describes five important aspects in ensuring the safe carriage of any load, which are:

- Selecting The Vehicle;
- Positioning The Load;
- Recognising Unstable Loads;
- Using Dunnage;
- Loading and Unloading;
- Do's and Don'ts

To demonstrate the principles described in this Section, ***lashings have been omitted from the illustrations.***

The following are your responsibilities:

- It is the responsibility of the driver, the vehicle owner and the vehicle operator to ensure the vehicle used is suitable for the type of load.
- It is the responsibility of the consignor including the original consignor of the freight, to provide the person in charge of the loading and the driver with any available information on the weight of each load and the centre of mass of the load or each item in a load.
- It is the responsibility of the person in charge of the loading and the driver to ensure the load is correctly positioned on the vehicle.
- It is the responsibility of the vehicle operator, the person in charge of the loading and the driver to ensure any dunnage is correctly chosen, positioned and restrained on the vehicle.
- It is the responsibility of the person in charge of the unloading to ensure unloading does not present any danger to any person.

1 SELECTING THE VEHICLE

A vehicle must be of a design suitable for the type of load carried. It must have adequate load-carrying capacity and sufficient space for the load.

When a vehicle is loaded, the manufacturer's tyre and axle load capacity, the Gross Vehicle Mass (GVM) or Aggregate Trailer Mass (ATM) and, where applicable, Gross Combination Mass (GCM) must not be exceeded.

The carrying capacity of a vehicle (or trailer) is its GVM (or ATM) less its Tare mass.

The legal mass limits as required by Federal, State and Local Government jurisdictions must not be exceeded.

Vehicles carrying long loads should be long enough to avoid excessive overhang and to ensure good weight distribution for vehicle stability.

Figure B.1 shows a long load on a short vehicle resulting in excessive rear overhang, poor weight distribution and loss of steering ability.

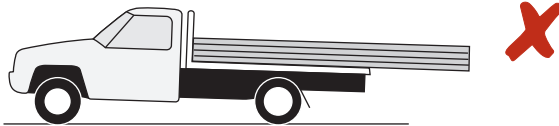


Fig. B.1

VEHICLE TOO SMALL

Figure B.2 shows the same long load on a longer vehicle with no rear overhang and good weight distribution.

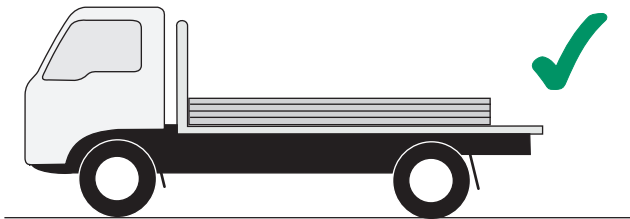


Fig. B.2

CORRECT CHOICE OF VEHICLE



Section B - Arranging Loads on Vehicles

Vehicles carrying liquids and loose bulk material must be designed to completely contain the load and to minimise the effect of load movement on the vehicle's stability. Open vehicles designed for carrying loose bulk material must be fitted with a cover, or the load must be wetted, skinned or otherwise contained, if there is a possibility of any of the load being blown off. The use of 'wetting' or 'skinning' agents can be effective for a limited time in restraining fine particles without the need for tarpaulins. Large tanks must be adequately baffled if not almost full or empty when transported.

The higher the position of the centre of mass of the load is above the ground, the lower the speed will be at which the vehicle will overturn when cornering (the centre of mass is also called the centre of gravity 'C of G').

Special precautions must be taken when carrying a load with a high centre of mass. The load should be carried on a vehicle with a low platform height (e.g. drop frame trailer or low loader) or on a vehicle with good roll stability (see Figure B.3).

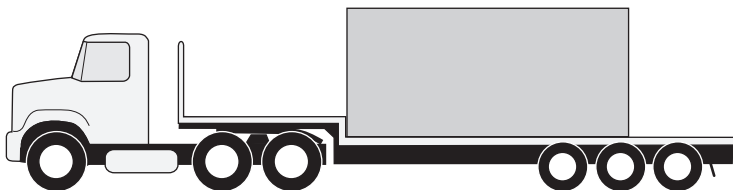


Fig. B.3 **DROP DECK TRAILER FOR MAXIMUM STABILITY**

The overall height of a loaded vehicle must not exceed the height of any obstruction (eg. bridge or overhead wire) likely to be encountered on a journey and the legal limit (generally 4.3 metres).

2 POSITIONING THE LOAD

Incorrect positioning of the load on a vehicle can result in a significant safety risk.

The load must be positioned to maintain adequate stability, steering and braking, and not overload tyres and axles.

A load should be positioned so that its centre of mass is as low as possible and not offset to one side of the vehicle. Positioning the load in this way will reduce the vehicle's tendency to overturn when cornering. This can be achieved by loading heavy objects first and placing them close to the centre-line of the vehicle (see Figures B.4 & B.5).

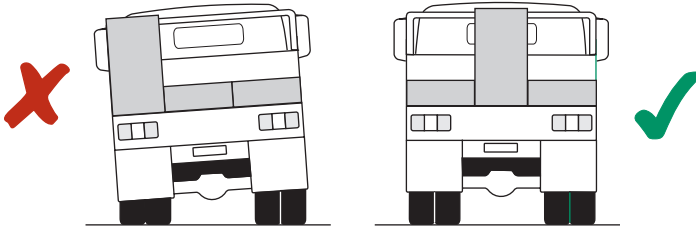


Fig. B.4 **INCORRECT POSITION** Fig. B.5 **CORRECT POSITION**

Where mixed loads are 'contained' on a vehicle, weak crushable items should be placed behind (or on top of) strong items to prevent damage during heavy braking.



Section B - Arranging Loads on Vehicles

A load placed against a headboard is easier to restrain, but it can place too much weight on the steer axle and can have a high centre of mass. Heavy loads should not be carried this way (see Figure B.6).

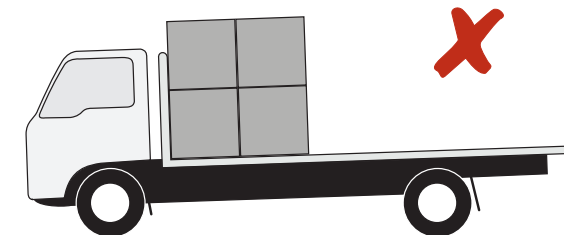


Fig. B.6 **INCORRECT LOAD POSITION** (overloads front axle)

If the front axle is overloaded, the load must be placed further back for better weight distribution and arranged so its centre of mass is as low as possible (see Figure B.7).

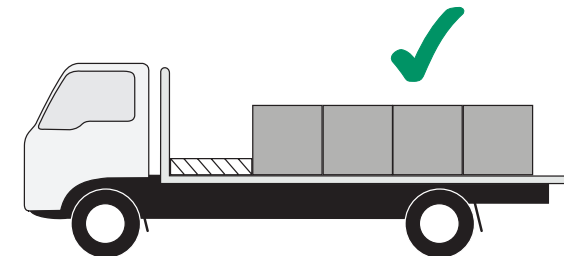


Fig. B.7 **CORRECT LOAD POSITION**

A load should be arranged so its centre of mass is in front of the centre of the rear axle or rear axle group on utilities, trucks and trailers.

This will ensure sufficient weight on steer axles to ensure safe steering and not overload the rear axle (see Figure B.8).

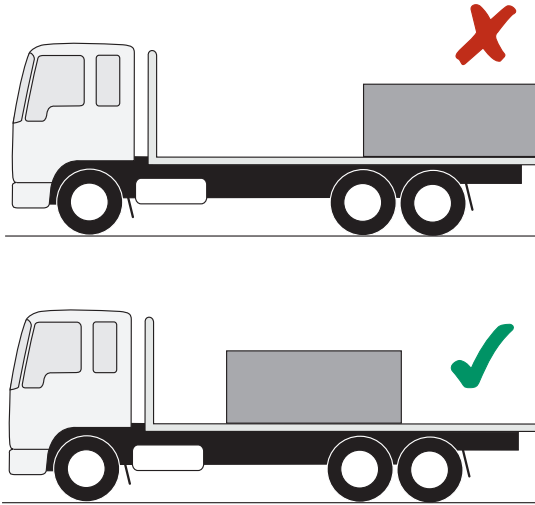


Fig. B.8 **KEEP WEIGHT ON STEER AXLES**

When loaded, the centre of mass of a drawbar trailer, including its load, must be in front of the centre of the axle group, to minimise trailer sway (see Figure B.9). This means that the trailer coupling should push down on the towbar, not exceeding the manufacturer's ratings of the coupling and towbar.

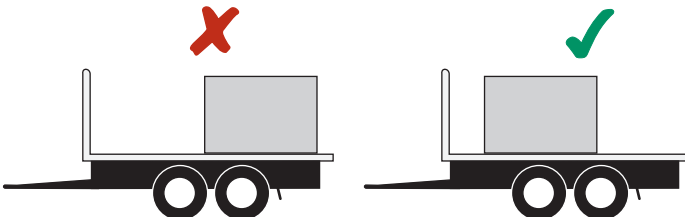


Fig. B.9 **PREVENT TRAILER SWAY**



Section B - Arranging Loads on Vehicles

The centre of mass of the load should be in front of the rear axle of a semi-trailer to provide enough weight on drive axles of the prime mover for traction and stability (see Figures B.10 & B.12).



Fig. B.10 **INSUFFICIENT WEIGHT ON DRIVE AXLES**

Heavy objects should be loaded first and positioned to provide even loading across the deck and shared loading between axles. To prevent excessive flexing of the middle of long trailers, heavy items or the dunnage supporting long lengths should be placed over the axle groups, where possible (see Figures B.11 & B.12).

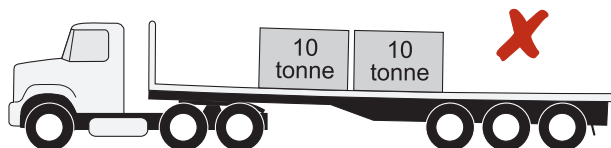


Fig. B.11 **EXCESSIVE TRAILER FLEXING**

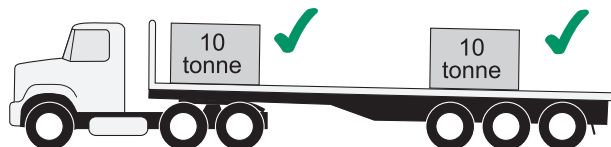


Fig. B.12 **GOOD WEIGHT DISTRIBUTION**

The vehicle's axle loads resulting from the positioning of the load may be obtained by weighing or calculation. The axle loads depend on the position of the centre of mass of the load.

Moving the bottom dunnage forward or rearward without moving the load will not change the axle loads of load sharing suspensions (see Figure B.13)

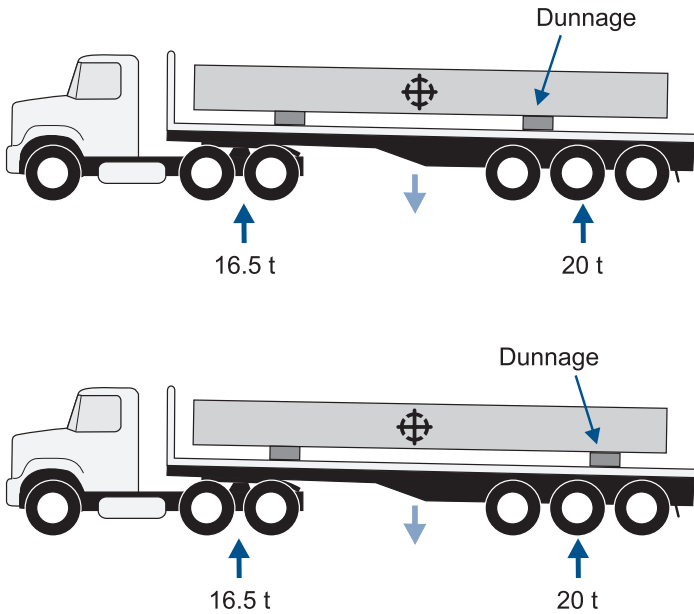


Fig. B.13 **DUNNAGE POSITION – NO EFFECT ON AXLE LOADS**



Section B - Arranging Loads on Vehicles

A load which has any potentially dangerous projection should be placed to minimise the risk to the driver or any other person, in the event of the load shifting during braking or a collision (see Figures B.14 & B.15).

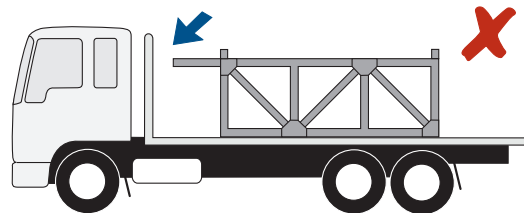


Fig. B.14

DANGEROUS POSITION

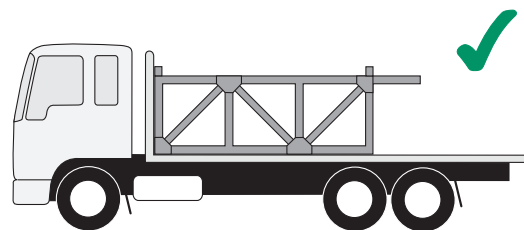


Fig. B.15

CORRECT POSITION

The load should not project from the front, sides or rear of a vehicle because it could cause danger to other road users or damage to property.

A load that projects beyond the rear of a vehicle by more than 1.2 metres (where Regulations permit) must be made conspicuous in daytime by fixing a brightly coloured flag or piece of material with each side at least 300mm long and at night by a red light which can be seen for 200 metres. Rear overhang limits may also apply.

3 RECOGNISING UNSTABLE LOADS

Tall loads can tip over under heavy braking or cornering. This can happen even if they are restrained properly at the base.

A load will be less stable if it is placed on a base such as timber dunnage that is narrower than the base of the load.

Tall loads are unstable in the forward direction, if the length (L) measured along the vehicle, is less than 80% of the height (H) (see Figure B.16). This applies to evenly shaped loads of the same material throughout such as paper rolls, 205 litre drums, or gas cylinders.

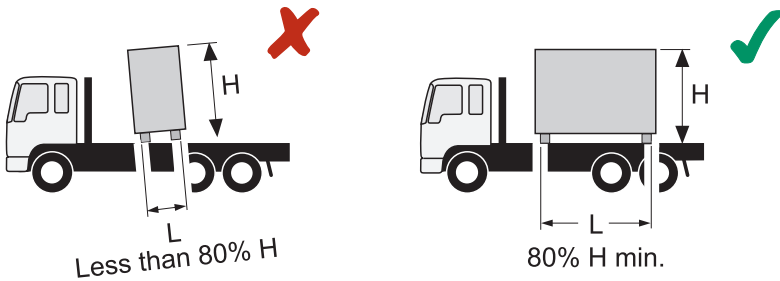


Fig. B.16 UNSTABLE FORWARDS

Tall loads are unstable sideways if the width (W) measured across the vehicle, is less than 50% of the height (H) (see Figure B.17).

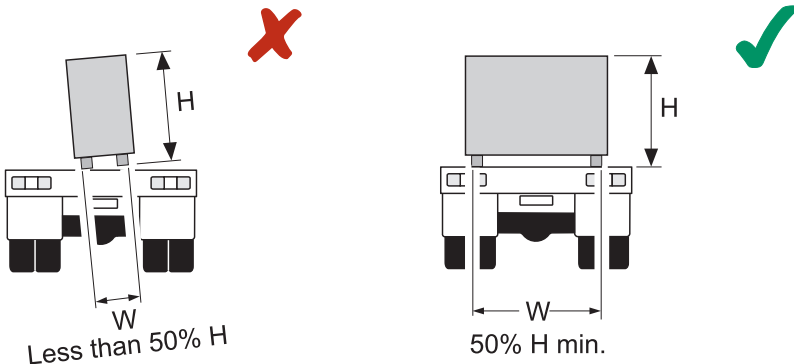


Fig. B.17 UNSTABLE SIDWAYS



Section B - Arranging Loads on Vehicles

Fully tensioned tie-down lashings will increase the stability of the load. Care should be taken when using rope or webbing straps to stabilise a load, because of the amount that these lashings can stretch. Ropes may stretch up to 20% and some webbing straps may stretch up to 13% of their length, before reaching their Lashing Capacity. This amount of stretch may allow the load to tip over. Chains are much more effective in preventing unstable loads tipping, because they don't stretch as much (about 1% of their length, up to their Lashing Capacity).

Lashings can be attached directly to the load to prevent tipping. These lashings are most effective if attached to the upper half of the load and angled no more than 60 degrees to the horizontal, in the opposite direction to tipping (see Figure B.18).

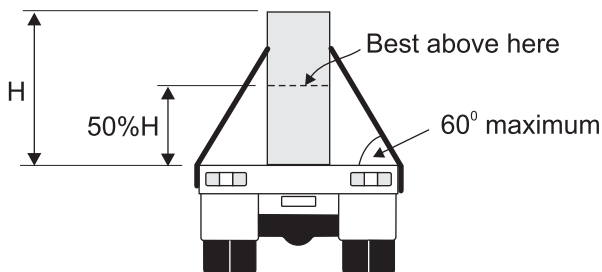


Fig. B.18 **ATTACHING DIRECT LASHINGS TO UNSTABLE LOADS**

Where a tall, unstable load is fragile or of uneven shape such as a transformer, it may not be possible to stabilise or prevent it tipping by attaching direct lashings. In such cases the load should be supported by a specially constructed frame and the frame restrained.

Unstable loads can be placed against a rigid structure, such as a headboard, to prevent them from tipping (see Figure B.19).

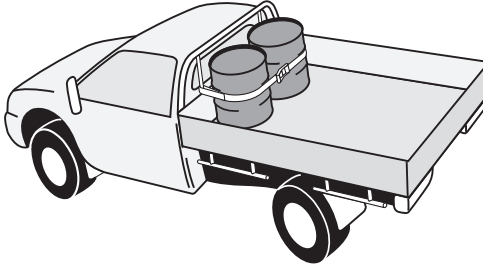


Fig. B.19

STABILISED LOAD

Alternatively, several unstable items of load can be strapped together to form a stable pack (see Figure B.20).

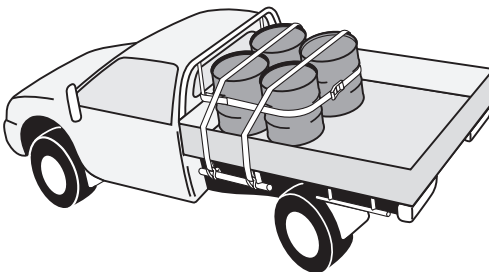


Fig. B.20

STABLE PACK

Section B - Arranging Loads on Vehicles

4 USING DUNNAGE

Dunnage is the packing placed under or between parts of the load. It is used to allow loading and unloading using forklifts or lifting slings.

Most dunnage is made from square or rectangular hardwood or softwood timber. Some loads require inter-layer packing that prevents contact between the timber and the load and acts as a moisture barrier. Inter-layer packing includes anti-slip rubber matting bonded to the top and bottom faces of the dunnage, plastic wrapping and plastic strips. These packing materials change the amount of friction between the load and the vehicle deck and other parts of the load. The use of slippery plastic wrapping means that more tie-down lashings are required than with timber alone, whilst the use of anti-slip rubber matting usually means that fewer lashings are required.

Rectangular dunnage is sometimes wrongly placed on its narrow face or stacked directly on top of itself (see Figure B.21), so that the tines of a forklift can fit under the load. This can be dangerous because the dunnage can roll under heavy braking. If the dunnage rolls, the lashings can loosen and all restraint can be lost.

To prevent the dunnage from rolling, it can be placed on its wide face. Dunnage that is placed directly on the deck can be bolted to the deck or fitted with special stabilising brackets. For heavy loads restrained by tie-down chains, it is recommended that square hardwood dunnage that is at least 63 mm thick, or softwood dunnage that is at least 100 mm thick, is used.

If the height of the dunnage needs to be raised (for uneven loads) it should be stacked alternatively at right angles to keep it stable.

If the dunnage spans between support points it must be strong enough to support the weight of the load, the tie-down clamping forces and the shock from bumps. If the dunnage is not strong enough, additional supports should be added or stronger dunnage used or, alternatively, the load rearranged.

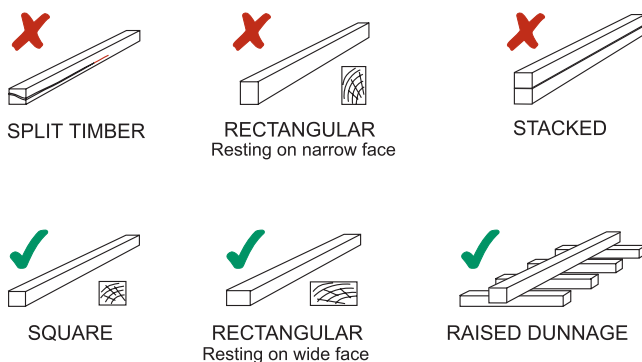


Fig. B.21

DUNNAGE DO'S & DON'TS

Timber which is used for dunnage should be relatively free of knots and splits. For heavy loads, such as large steel sections that are supported on small areas of contact, the dunnage should be strong enough to prevent it crushing or splitting.

If the load has multiple layers of lengths of rigid sections, the upper rows of dunnage should be placed directly above the bottom dunnage (see Figure B.22). If the dunnage is placed between lashing positions it can work loose when the vehicle and load both flex during a journey. If the dunnage works loose and falls out it could cause an accident.

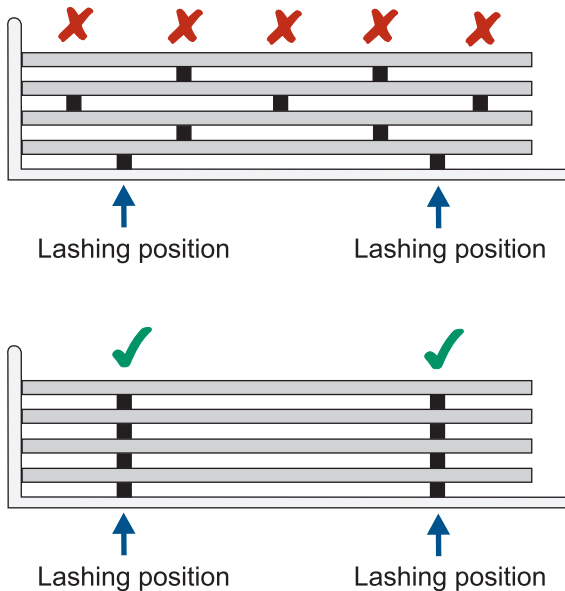


Fig. B.22

POSITIONING DUNNAGE

Very rigid loads, such as large diameter steel pipes and concrete beams, should be supported in only two positions to allow the vehicle to flex. If the lashings are placed between the dunnage positions they can break or loosen when the vehicle and/or the load flexes. This could allow the load to move.

Flexible loads, such as plastic pipes, require additional dunnage positions (and lashings) to be used along with their length. Individual, flexible lengths can be restrained with lashings between the dunnage positions.

Remember to secure all dunnage when the vehicle is travelling empty. Even a small piece can be a dangerous missile to other road users.



Section B - Arranging Loads on Vehicles

5 LOADING AND UNLOADING

The load should always be packed, located and restrained in a way that allows its safe loading and unloading.

When throwing lashings over the vehicle, be careful that no-one is standing on the other side. Before throwing the lashings, check there is no obstruction above the vehicle and electric cables that could come into contact with the lashings.

When opening doors, gates, sides and side curtains and when removing lashings and tarpaulins take care that loads that may have shifted during a journey, do not dislodge and cause injury. When releasing the tension in lashings, be careful of any sudden uncontrolled movement of handles, cheater bars, sharp steel strapping and hooks on lashings and elastic straps.

Forklift operations are a major cause of injury to drivers and loaders. When a vehicle is being loaded or unloaded by forklift, make sure that you are always in full view of the forklift driver. Do not approach a forklift whilst it is moving.

Do not stand or work on one side of the vehicle if the other side is being loaded or unloaded. Part of the load may be pushed onto you during the loading or unloading operations.

6 DOs AND DON'Ts

- DO** make sure that the vehicle's load space and loading deck are suitable for the type and size of the load.
- DO** check the weight of the load to be carried.
- DO** check the positioning of the load along the vehicle.
- DO** consider the positioning of the load after partially loading or partially unloading the vehicle.
- DO** position the load evenly across the vehicle.
- DO** provide extra restraint for tall loads.

- DON'T** overload your vehicle or its individual axles.
- DON'T** load your vehicle too high.
- DON'T** overload the steer axle by placing the load too far forward.
- DON'T** reduce the weight on the steer axle by placing the load too far back.
- DON'T** allow the load to project dangerously towards the cabin or outside the vehicle.
- DON'T** place rectangular dunnage on its narrow face.



This load of logs was not properly restrained and fell off on a corner. In this case no pedestrians or other road users were injured.



It was reported that hay bales shifting on a bumpy corner caused this rollover. It therefore was probably not restrained to meet the Performance Standards. *(Photo courtesy The Standard, photographer Leanne Gourley).*



Poor load restraint caused the heavy steel sections to move and cause the rollover.



The base of the load broke from the strapping tie-down force. The strap should have been positioned above the dunnage supporting the load. (Photo courtesy Queensland Transport).



This truck is carrying a concrete tank with a single chain around its base. Both ends of the chain are attached to the same point at the middle of the headboard (see photo insert). There is no tie-down to prevent the tank shifting sideways on a bumpy corner.



A few ropes and a knotted webbing strap will not hold this load of steel.



Too much weight behind the rear axle can give poor steering and braking on the front axle (see page 219).



Tall loads can be unstable and require special loading and restraint methods (see pages 43, 44)



The shipping container bent this trailer. It is important to know the weight of the load and its centre of mass and then to position it correctly on the appropriate vehicle.



This trailer was not strong enough. Its frame broke in front of the wheel from the weight of the load.



Use a suitable vehicle. The overhanging load can reduce the weight on the front axle and steering capacity. The excessive overhang is a danger to other road users.



Section B - Arranging Loads on Vehicles



SECTION C

RESTRAINING LOADS ON VEHICLES

CONTENTS	
1	HOW MUCH LOAD RESTRAINT? 58
2	TIE-DOWN 60
2.1	Friction ----- 60
2.2	Applying Tie-down Lashings ----- 62
2.3	Tie-down Lashings: Angles ----- 63
2.4	Tie-down Lashings: Pre-tension ----- 64
2.5	Tie-down Lashings: Tensioning by Load Shift ----- 65
2.6	Tie-down Lashings: How Many and How Strong? ----- 65
3	DIRECT RESTRAINT 68
3.1	Direct Lashing Angles ----- 69
3.2	Lashing Positions ----- 70
3.3	Rubber Tyre Bouncing ----- 70
3.4	Direct Lashings – What Strength? ----- 71
4	VEHICLES AND LOAD RESTRAINT EQUIPMENT 73
4.1	Pantechicon Bodies, Tippers, Tankers and other Specialised Bodies ----- 73
4.2	Bins, Skips, Stillages, Removable Tanks, Closed and Open Containers ----- 73
4.3	Chocks, Cradles and Trestles ----- 73
4.4	Headboards and Loading Racks ----- 73
4.5	Barriers ----- 74
4.6	Side Gates ----- 75
4.7	Pins, Pegs, Stanchions and Bolsters ----- 76
4.8	Side Curtains ----- 76
4.9	Tarpaulins ----- 78
4.10	Tie Rails ----- 78
4.11	Lashings ----- 78
4.12	Ropes ----- 79
4.13	Webbing ----- 79
4.14	Chain ----- 80
4.15	Strapping ----- 80
4.16	Stretch and Shrink Wrapping ----- 80
4.17	Wire Rope ----- 80
4.18	Elastic Straps ----- 80



5	TENSIONERS	81
6	USING LOAD RESTRAINT EQUIPMENT	84
6.1	Attaching Lashings to Tie Rails -----	84
6.2	Protecting Lashings and Loads -----	85
6.3	Using Ropes and Knots -----	85
6.4	Using Webbing and Tensioners -----	87
6.5	Using Chains and Tensioners -----	87
6.6	Using Wire Rope and Winches -----	89
6.7	Using Tarpaulins -----	89
6.8	Using Elastic Straps -----	91
6.9	Storage of Equipment -----	91
7	WEAR AND DAMAGE	91
8	DOs AND DON'Ts	92



This Section describes how to determine the amount of load restraint required using either tie-down or direct restraint methods. It includes the following:

- How Much Load Restraint?
- Tie-down
- Direct Restraint
- Vehicles and Load Restraint Equipment
- Tensioners
- Using Load Restraint Equipment
- Wear and Damage
- Do's and Don'ts

The following are your responsibilities:

- It is the responsibility of the owner, the driver and the person in charge of loading, to ensure that the vehicle's load restraint structure, attachments and load restraint equipment are suitable for the application and are serviceable and functional.
- It is the responsibility of the person in charge of loading and the driver, to ensure that a load is properly restrained by the vehicle load restraint structure, attachments and load restraint equipment using safe operating procedures.
- It is the responsibility of the person in charge of unloading and the driver, to ensure that load restraint equipment is released and removed using safe operating procedures and that the load is removed safely from the vehicle.



Section C - Restraining Loads on Vehicles

1 HOW MUCH LOAD RESTRAINT?

All loads must be restrained to meet the Performance Standards outlined in Section F 'Performance Standards'.

A performance standard is a way of defining what is required, but not how to do it. For example, braking performance is defined as a stopping distance, not by the size of the brakes. Performance standards allow you to choose the way to do it.

Many different types of load restraint systems can be used to meet the load restraint performance standards. For example, webbing straps with rubber load mat can be used instead of chains for restraining smooth steel.

During all expected operating conditions, which can include minor collisions, the load restraint system must ensure that:

- (1) The load does not dislodge from the vehicle; and
- (2) Unacceptable load movement does not occur.

Limited load movement is acceptable under conditions where the vehicle's stability and weight distribution are not adversely affected and the load cannot become dislodged from the vehicle. The following are examples of acceptable load movement under these conditions:

- (1) Limited vertical movement of loads that are restrained from moving horizontally (by vehicle sides or gates, for example);
- (2) Limited movement of very lightweight objects, loose bulk loads and bulk liquids that are contained within the sides of enclosure of a vehicle body; and
- (3) Limited forward (or rearward) movement of loads that are tied down, where the maximum tension that develops in each tie-down does not exceed its Lashing Capacity.

For loads that do not move on the vehicle, the performance standards outlined in Section F will be met if the load restraint system is capable of providing each of the following:

- (i) Restraining forces equal to 80% of the weight of the load to prevent the load shifting forwards (e.g. braking in the forward direction);
- (ii) Restraining forces equal to 50% of the weight of the load to prevent the load shifting rearward (e.g. braking in reverse); and
- (iii) Restraining forces equal to 50% of the weight of the load to prevent the load shifting sideways (e.g. during cornering).

combined with restraining forces equal to 20% of the weight of the load (additional to the load's own weight) to prevent the load moving vertically relative to the vehicle.

Where limited vertical movement is permissible for loads that are restrained from moving horizontally, only the above forward, rearward and sideways restraining forces must be provided by the load restraint system.

Where limited forward or rearward load movement of loads that are tied down is permissible, the required restraining forces will be greater than the above and must be determined by testing or calculation.

For example, the minimum horizontal restraint required to prevent movement of a 10 tonne load is shown in Figure C.1:

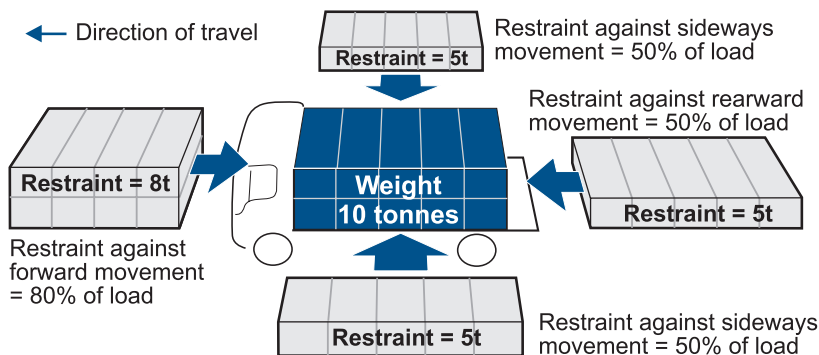


Fig. C.1 **MINIMUM HORIZONTAL RESTRAINT REQUIRED**

The restraint required in the forward direction will prevent load shift on all heavy vehicles and most light vehicles during emergency braking and even some light collisions. The sideways restraint required will prevent load shift even to the point of roll-over on most heavy vehicles.

In addition to the forces above, the 10 tonne load requires a minimum vertical restraint as shown in Figure C.2. (Note that this vertical restraint is not required for certain loads that are effectively contained on the vehicle).

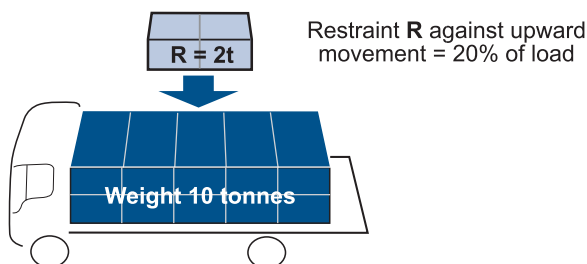


Fig. C.2 **MINIMUM VERTICAL RESTRAINT REQUIRED**

In some cases, the restraint required in all four directions can be provided by a single tie-down lashing.

Where tie-down lashings are used, a downward force of at least 20% of the weight of the load should be applied by the initial tightening of the lashings. This will usually ensure that there is always friction between the load and the vehicle over bumps and on rough roads.

Section C - Restraining Loads on Vehicles

2 TIE-DOWN METHOD

Tie-down is load restraint using friction. The pre-tension in a tie-down lashing gives the same effect as holding the load with a 'giant' G-clamp. The friction stops the load moving.

If the load does not shift, it is not the strength of the lashing that determines the holding ability of a tie-down lashing. It is determined by the amount of tension in the lashing from initially tightening the knot, or operating the ratchet, winch or dog, in conjunction with the amount of friction present.

Tie-down should not be used on slippery loads because too many lashings are needed.

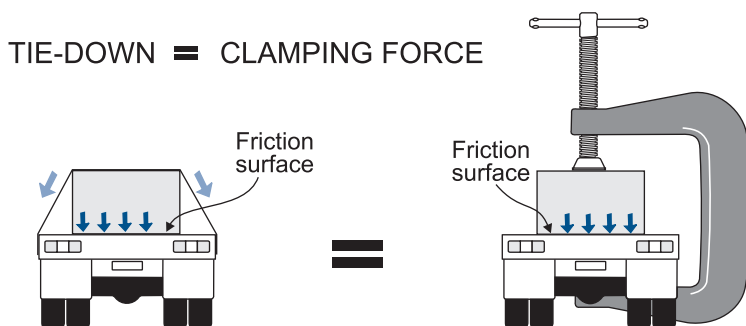


Fig. C.3

CLAMPING THE LOAD

2.1 Friction

Friction is the resistance to movement caused by the 'roughness' of two surfaces in contact with each other.

For example, rubber is used to cover a slippery metal brake pedal so as to increase friction and stop the driver's foot slipping off.

A simple method of testing friction is by tipping the surfaces until sliding occurs. Slippery surfaces slide at low angles and rough surfaces slide at higher angles (see Figure C.4).

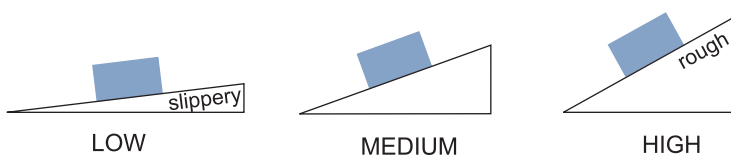


Fig. C.4

FRICION COMPARISON

Table C.1 shows a comparison of the amount of friction present with some typical loads.

TYPICAL FRICTION LEVELS	
Load	Friction
Wet or greasy steel on steel	VERY LOW
Smooth steel on smooth steel	LOW
Smooth steel on rusty steel	LOW TO MEDIUM
Smooth steel on timber	MEDIUM
Smooth steel on conveyor belt	MEDIUM
Rusty steel on rusty steel	MEDIUM TO HIGH
Rusty steel on timber	HIGH
Smooth steel on rubber load mat	HIGH

Table C.1

Friction depends only on the type of surfaces and the force between them.

Friction force is independent of the amount of surface area in contact.

For example, there is no difference between the friction from a 'checker plate' or a flat plate that are made from the same metal. Similarly, adding extra timber dunnage under a load will not increase the friction force. As shown in Figure C.5, a horizontal force of 4 tonnes will just move the 10 tonne load regardless of whether there are two, four or more pieces of dunnage underneath.

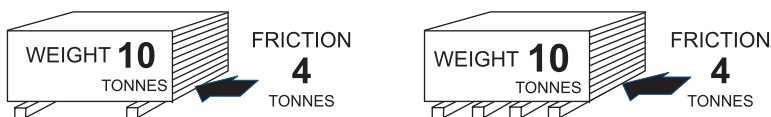


Fig. C.5 EXTRA CONTACT AREA – NO EFFECT

Friction between smooth surfaces can be increased using timber or anti-slip rubber matting. Oil or water between metal surfaces act as lubricants and reduce the friction. Friction can also be greatly reduced if there is dust, sand or other particles between the surfaces.



Section C - Restraining Loads on Vehicles

2.2 Applying Tie-Down Lashings

Tie-down lashings are used to help restrain a load using friction.

Tie-down lashings are ropes, straps or chains which normally pass over the top of a load and are attached to the vehicle on either side (see Figure C.6). They may also pass through or be attached to a load. They are pre-tensioned using knots or mechanical tensioners to increase the clamping force under the load.

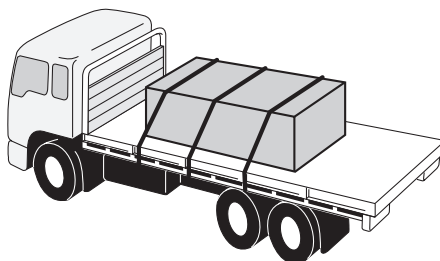


Fig. C.6

TIE-DOWN LASHINGS

The lashings must be correctly pre-tensioned. If they loosen below the minimum required pre-tension during a journey, the friction forces are reduced and the load could shift.

If a load is not tied down, friction cannot be considered as part of the load restraint system. Unrestrained loads, even on high friction surfaces, can bounce when travelling over uneven road surfaces and then shift during changes in speed, direction or slope.

If the load is crushable or could be damaged by the lashing during tensioning, tie-down is not a suitable restraint method.

Tie-down lashings used on offset loads can loosen if the load shifts sideways (see Figure C.7). Such movement can be sudden and without warning. Offset loads should be blocked or directly restrained to prevent sideways movement.

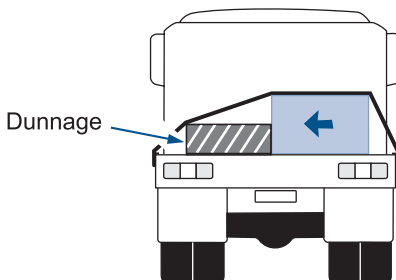


Fig. C.7

OFFSET LOAD (slippage loosens lashings)



2.3 Tie-Down Lashings: Angles

Tie-down lashings are most effective if they are vertical and tight.

The more a lashing is angled from the vertical, the less is the clamping force. The clamping force is very small when the lashing is near horizontal.

The lower the lashing angle, the more lashings are required to give the same clamping force.

For example, a strap tensioned to 500 kg and angled at 15 degrees to the horizontal, will only provide a clamping force of 125 kg (25%) on one side of the load. A vertical strap, would therefore provide four times the clamping force (the full 500 kg tension) on that side of the load.

One strap at 90 degrees is therefore equivalent to four straps at 15 degrees. This is called the 'angle effect'. For more information on the angle effect, see Section F, page 189.

Many loads are not high enough for tie-down lashings to be used effectively (see Figure C.8).

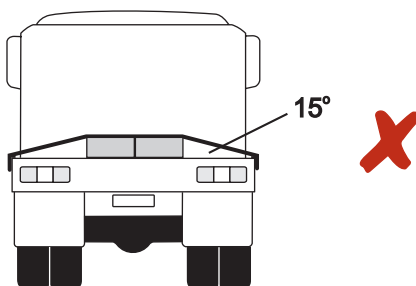


Fig. C.8 **LOW TIE-DOWN ANGLE (not recommended)**



Section C - Restraining Loads on Vehicles

Dunnage can be used to increase the lashing angles, by lifting the load (see Figure C.9),

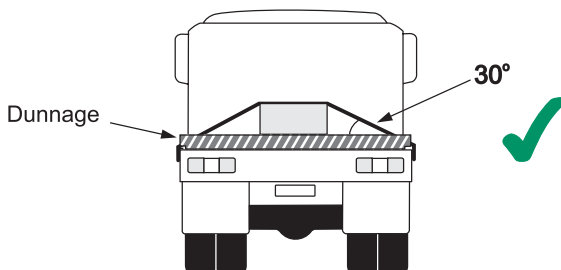


Fig. C.9 **HIGHER TIE-DOWN ANGLE (more effective)**

when placed on top of the load (see Figure C.10),

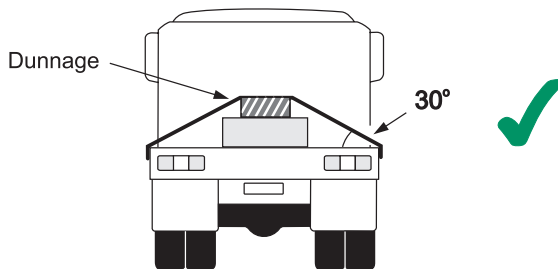


Fig. C.10 **HIGHER TIE-DOWN ANGLE (more effective)**

or by separating parts of the load (see Figure C.11).

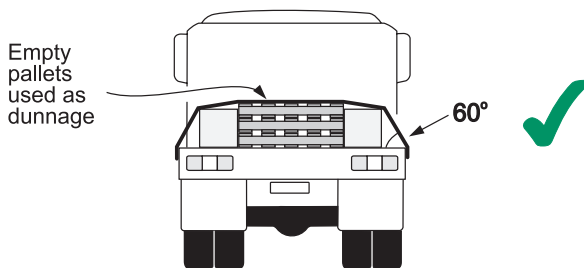


Fig. C.11 **HIGHER TIE-DOWN ANGLE (recommended)**



2.4 Tie-Down Lashing: Pre-Tension

To maintain the friction force during normal driving, the load must always remain in contact with the vehicle including during bumps and vibration from rough road surfaces. To achieve this, the tie-down lashings must be correctly tensioned at all times.

The lashing tension is greater on the side of the load where it is tensioned. The lashings lose tension where they catch or stick on sharp corners or rough surfaces on the load. The tension on the other side of the load, can be more than 50% lower. To prevent the lashing losing tension, smooth rounded corner protectors should be used.

To ensure even load restraint, it is recommended that every second tensioner should be placed on the opposite side of the vehicle. Alternatively, two tensioners can be used on each lashing, one on each side of the load and this can increase the clamping force by approximately 20%.

Table C.2 is a guide to the average tension that can be achieved by an 'average' operator. Some operators can achieve two to three times these levels. Different makes or models of equipment can also produce higher or lower tensions. It is important to know what tension you can get with your equipment.

AVERAGE PRE-TENSION			
Lashing	Size	Tensioner	Pre-tension
Rope	10 mm &	Single Hitch	50 kg
	12 mm	Double Hitch	100 kg
Webbing Strap	25 mm	Hand Ratchet	100 kg
	35 mm	Hand Ratchet	250 kg
	50 mm	Truck Winch	300 kg
	50 mm	Hand Ratchet (push up)	300 kg
	50 mm	Hand Ratchet (pull down)	600 kg
Chain	7 mm & above	Dog	750 kg
		Turnbuckle	1000 kg

Table C.2 (Also appears as Table F.2 in Section F and in Section K – Tables. Refer to notes on page 260.)

2.5 Tie-Down Lashings: Tensioning by Load Shift

Some specialised load restraint systems incorporate limited forward load shift to increase the pre-tension in the lashings up to their rated lashing capacity. Further information on this form of restraint is contained in Section F.

2.6 Tie-Down Lashings With No Load Shift: How Many and How Strong?

The required number and strength of tie-down lashings will depend on:

- the weight of the load,
- the friction (grip) between all of the load surfaces, and
- the clamping force from the tie-down lashings.

Section C - Restraining Loads on Vehicles

Tie-down lashings are most effective when there is high friction between the vehicle and load surfaces. Vehicle loading decks and loads should therefore be free of oil, grease, water, dirt and other contaminants that may reduce friction.

Where a load has low friction between the surfaces in contact, the friction can be greatly increased by using appropriate inter-layer packing, e.g. rubber matting or timber dunnage. The load can then be restrained with fewer lashings.

Table C.3 gives the weight of load that one tie-down lashing can restrain, either when the load is blocked in front or with no blocking, for the average lashing tension nominated. Load restraint systems with greater average lashing tension (or based on limited forward load shift) or where the load is blocked sideways can have greater restraint capacity.

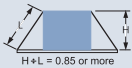




MAXIMUM WEIGHT RESTRAINED BY ONE LASHING (with no load shift)					
FRONT OF LOAD BLOCKED?		NO		YES	
HOW MUCH FRICTION?		MEDIUM	HIGH	MEDIUM	HIGH
		(Smooth Steel on Timber) $\mu = 0.4$	(Rubber Load Mat) $\mu = 0.6$	(Smooth Steel on Timber) $\mu = 0.4$	(Rubber Load Mat) $\mu = 0.6$
	Lashing angle 60° or more to horizontal				
ROPE - Single Hitch (50 kg average tension)		85 kg	255 kg	340 kg	425 kg
ROPE - Double Hitch (100 kg average tension)		170 kg	510 kg	680 kg	850 kg
WEBBING STRAP (300 kg average tension)		510 kg	1530 kg	2040 kg	2550 kg
CHAIN (750 kg average tension)		1275 kg	3825 kg	5100 kg	6375 kg

Table C.3

(Also appears in Section K – Tables)

To find the number of lashings required for any load, divide the total weight of the load by the weight that each lashing can restrain and then round the answer up to the next whole number.

The weights in this table are for loads where the lashing is nearly vertical between the tie rail and where it contacts the load. (Note: If the load is low and the lashing is nearly horizontal, the number of lashings required could be more than four or five times than indicated by the table.)

If rubber load mat is used under an unblocked load, one lashing can restrain three times the weight shown for medium friction (compare the second and third columns of Table C.3). Rubber load mat is cheaper than most lashings and the most cost effective method to reduce the number of lashings needed.

Tables for other lashing angles are in Section F and all the tables are reproduced in Section K at the back of this guide. They can be torn out and kept in your vehicle for later reference.

Example:

“A long steel trailer is loaded with two stacks of flat steel fabrications. The fabrications are the same width as the trailer. One stack is against a braced front loading rack. The other stack sits on the deck one metre behind the front stack. Each stack weighs 6 tonnes. The stacks are on timber and the fabrications in the stacks are separated by timber dunnage (see Figure C.12). How many tie-down webbing straps tensioned with truck winches are required on each stack?”

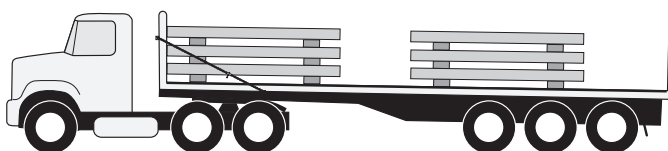


Fig. C.12

HOW MANY STRAPS?

Front Stack:

The front of the front stack is blocked against a loading rack braced back with chain on both sides. Refer to table C.3 **'FRONT OF LOAD BLOCKED? – YES'**.

All parts of the steel rest on timber. Refer to table C.3, the friction of all parts of the load is **'MEDIUM'**.

From column 4, one webbing strap can restrain 2040 kg.

The stack weighs 6000 kg. The number of straps required is therefore 3.

Rear Stack:

The front of the rear stack is not blocked. Refer to table C.3 **'FRONT OF LOAD BLOCKED? – NO'**.

All parts of the steel rest on timber. Refer to table C.3, the friction of all parts of the load is **'MEDIUM'**.

From column 2, one webbing strap can restrain 510 kg.

The stack weighs 6000 kg. The number of straps required is therefore 12.

This shows that there is not enough friction under the load as too many straps are required and they would be difficult to tension evenly.

Check again using rubber load mat.

If rubber load mat is placed between all steel and timber surfaces, refer to table C.3. The friction of all parts of the load is **'HIGH'**.

From table C.3, column 3, one webbing strap can restrain 1530 kg. The stack weighs 6000 kg. The number of straps required is therefore 4.



Section C - Restraining Loads on Vehicles

3 DIRECT RESTRAINT METHOD

Direct restraint is the restraint of a load by containing, blocking or attaching.

Direct lashings are ropes, webbing straps, chains or twist locks which attach a load to a vehicle. They can be attached to or pass through or around a load to directly restrain it (see Figure C.13).

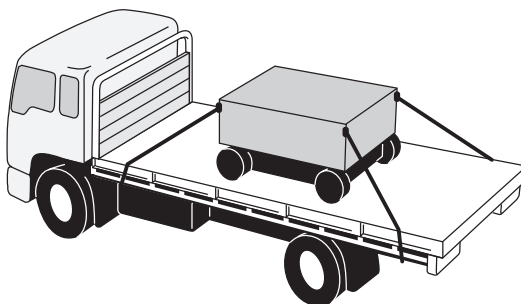


Fig. C.13

DIRECT LASHINGS

The lashings can provide all the necessary restraint if there is no friction between the load and the loading deck.

Direct lashings are suitable for restraining most loads, but especially:

- slippery loads, and
- loads on wheels.

Only one or two lashings are normally used to restrain a load in any direction, because it is difficult to share the forces between more than two lashings.

The lashings become tighter when the load restraint force is needed during cornering and braking.

Where loads on wheels are chocked or placed on blocks and the lashings are attached to the load, the restraint is often a combination of direct restraint and tie-down using friction.

Where loads on rubber tyred wheels are directly restrained forwards and rearwards they can often be restrained by tie-down in the sideways direction because of the friction between the rubber tyres and the deck. Tie-down can be used on solid metal wheels if rubber load mat is placed between the wheel and the deck.

3.1 Direct Lashing Angles

Lashings must be angled in directions opposite to any expected load movement. A lashing required to stop a load moving forward must be angled rearward and not vertically (see Figure C.14). A small downward angle is necessary to provide the required vertical restraint.

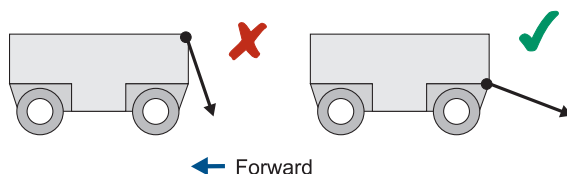


Fig. C.14 **DIRECT LASHING ANGLES** (front lashings not shown)

The recommended angle for direct lashing is a slope of 1 in 2 to the horizontal (see Figure C.15). This angle gives the best combination of horizontal and vertical restraint.

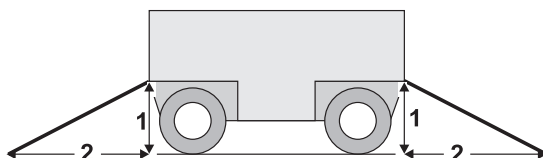


Fig. C.15 **RECOMMENDED DIRECT LASHING ANGLE**

When restraining loads with stiff rubber tyres, the lashings do not need to be angled sideways when the friction between the tyres and the deck provides the necessary restraint.

When restraining loads with steel wheels or tracks, the lashings need to be angled sideways. If the width of the load is about the same as the vehicle, the lashings should be attached so that they can be angled underneath or diagonally across the ends of the load.

Section C - Restraining Loads on Vehicles

3.2 Lashing Positions

The lashings can be attached at any position along a load. Figure C.16 shows a rubber tyred load directly restrained forwards and rearwards. When opposing direct lashings are attached at one end of the load, vertical tie-down lashings are required at the opposite end to prevent sideways movement.

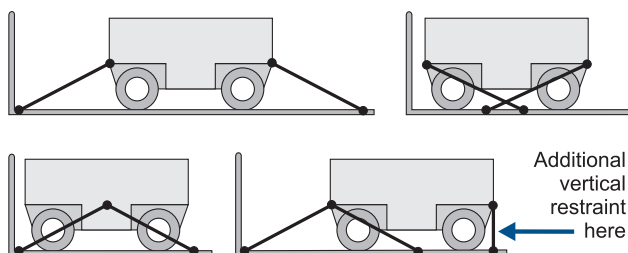


Fig. C.16 **ALTERNATIVE POSITIONS FOR DIRECT LASHINGS**

3.3 Rubber Tyre Bouncing

When pneumatic rubber tyred equipment is restrained with angled lashings, the lashings pull down on the load during braking. This downward force will squash rubber tyres and cause the load to bounce after braking (see Figure C.17). Bouncing causes wear in chains and lashing points, and can stretch or break the chains.

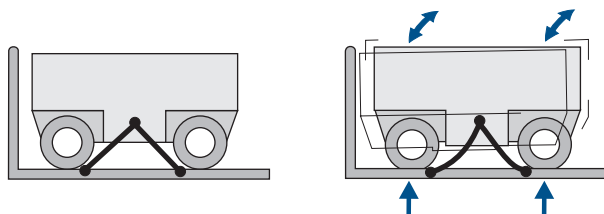


Fig. C.17 **RUBBER TYRE BOUNCE**

To minimise bouncing, direct lashings should be angled at no more than 25 degrees to the horizontal (1:2).

Further information is contained in Section E.



3.4 Direct Lashings – What Strength?

The strength required depends upon the weight of the load, the number of lashings and their direction. The lashing strength is the Lashing Capacity (LC) or manufacturer's rating, which should be marked on the lashing. Table C.4 contains the typical lashing capacity of some common lashings:

TYPICAL LASHING CAPACITY		
Lashing	Lashing Capacity (LC)	
12 mm synthetic (silver) rope	300 kg	
25 mm webbing	250 kg	
35 mm webbing	1.0 tonne	
50 mm webbing	2.0 tonnes	
chain*	with claw hooks or 'winged' grab hooks	with grab hooks or edge contact
6 mm transport chain	2.3 tonnes	1.7 tonnes
7.3 mm transport chain	3.0 tonnes	2.3 tonnes
8 mm transport chain	4.0 tonnes	3.0 tonnes
10 mm transport chain	6.0 tonnes	4.5 tonnes
13 mm transport chain	9.0 tonnes	6.7 tonnes
13 mm Grade 'T' chain **	10.0 tonnes	7.5 tonnes
16 mm Grade 'T' chain **	16.0 tonnes	12.0 tonnes

Table C.4

(Also appears in Section K – Tables)

* Note: Different hooks have different lashing capacities and chains that pass over sharp edges such as coaming rails have reduced lashing capacity (see Section C.6.5).

** Note: Grade 'T' lifting chain is also referred to as Grade 80 or 'Herc-alloy'.

Load tables can be used to select the correct lashing size for direct restraint application (see Section F).



Section C - Restraining Loads on Vehicles

A simple rule is to select lashings whose combined lashing capacity is:

- in the forward direction = twice the weight of load;
- in the sideways direction = the weight of load; and
- in the rearward direction = the weight of load.

This assumes the lashings are angled at less than 60 degrees to the appropriate direction of movement. However, lashings selected in this way will, in most cases, be stronger than necessary.

For example, to restrain a weight of 4 tonne (see Figure C.18) the following is required:

- in the forward direction, two chains (C & D) which are angled at 60 degrees or less to the rearward direction each with a lashing capacity of 4 tonnes;
- in the sideways direction, two chains (B & C or A & D) which are angled at 60 degrees or less to the sideways direction each with a minimum lashing capacity of 2 tonnes;
- in the rearward direction, two chains (A & B) which are angled at 60 degrees or less to the forward direction each with a lashing capacity of 2 tonnes.

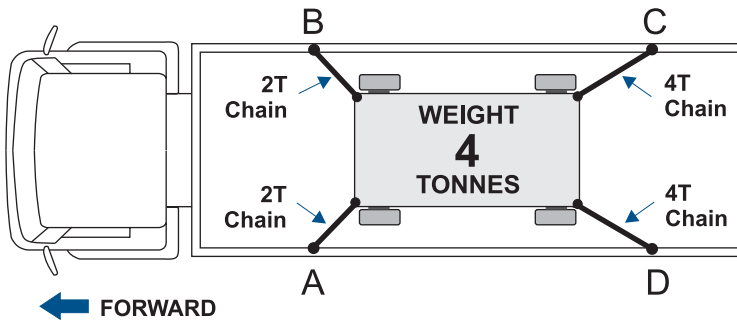


Fig. C.18 TOP VIEW OF DIRECTLY RESTRAINED 4 TONNE LOAD

4 VEHICLES AND RESTRAINT EQUIPMENT

The correct vehicle and load restraint equipment will depend on the type of load to be restrained.

Vehicle restraint structures, attachments, headboards, side gates, loading racks, roof racks and load restraint equipment must be strong enough for the application and must be in good working condition.

Loads could shift if there is a failure of any vehicle structure, attachment or load restraint equipment caused by inadequate strength, excessive wear or damage.

Section G '*Vehicle Structures*' contains detailed technical specifications and requirements for vehicle structures and attachments.

Section H '*Load Restraint Equipment*' contains detailed technical specifications and requirements for load restraint equipment.

4.1 Pantechicon Bodies, Tippers, Tankers and other Specialised Bodies

Bulkheads, side walls, tanks and other containment systems have a limit to their load restraint capacity. Their rating should be obtained from the manufacturer if not already marked somewhere on the body.

4.2 Bins, Skips, Stillages, Removable Tanks, Closed and Open Containers

Equipment that can contain items of load must have adequate strength to restrain the load and must have provision for keeping the load on or inside it. The equipment together with its load must be designed so that it can be adequately restrained to the vehicle.

4.3 Chocks, Cradles and Trestles

Equipment that can block or support items of load must have adequate strength to support the load. The equipment together with its load must be designed so that it can be adequately restrained to the vehicle. Chocks, or dunnage used as a chock, must be separately tied or attached to the vehicle or the load.

4.4 Headboards and Loading Racks

Most headboards and loading racks are not strong enough to fully restrain heavy loads under heavy braking. If the load is tied down to provide the required restraint for the sideways, rearwards and vertical directions, the headboard or loading rack can provide some or all of the extra restraint needed for heavy braking or minor collisions.

The capacity of lightweight tubular loading racks can be increased by chaining them near the top and then back to the vehicle tie rails on each side (see Figure C.19).

A single 9 metre chain around the front of the headboard or loading rack eliminates the need for individual attachments on each side and provides maximum shock resistance to resist breaking more than if two short chains are used, one either side of the rack. The chain is most effective if it is located at two thirds the height of the load. It does not need to be tensioned, only all the slack removed. An additional 40 mm square tube should be welded to the rack as this locates the chain properly and allows the chain to pass through its bore.



Section C - Restraining Loads on Vehicles

To help distribute and contain the load, plywood, metal sheeting or mesh can be used behind the rack. These sheets must, themselves, be restrained.

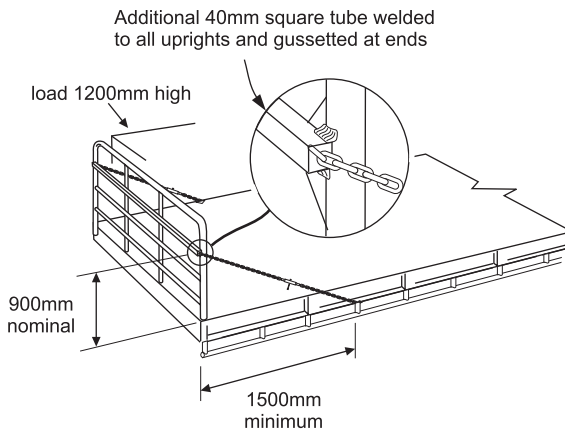


Fig. C.19 **CHAINING LOADING RACK (for 1200 mm high load)**

4.5 Barriers

To maintain axle weight limits, loads are often separated into two parts. To restrain the rear part, a movable barrier can be used. The barrier should be chained back near the top and bottom, to the tie rails on both sides (see Figure C.20).

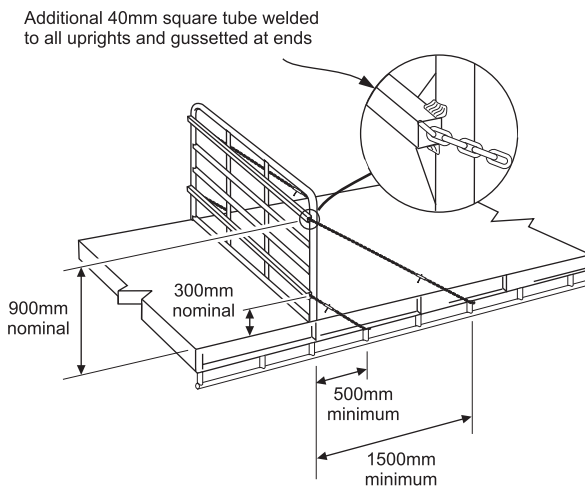


Fig. C.20

CHAINING MOVABLE BARRIER

4.6 Side Gates

Most drop-in side gates are not capable of restraining tall or stacked loads unless they are supported at the top by diagonal cross lashings to the opposite tie rails or are attached to other structures such as bulkheads or loading racks.

When straps are tensioned over the top of opposite gates, they clamp the load together and prevent the gates lifting.

If the load is stacked more than one high, the gates cannot prevent the top layers from tipping sideways (see Figure C.21).

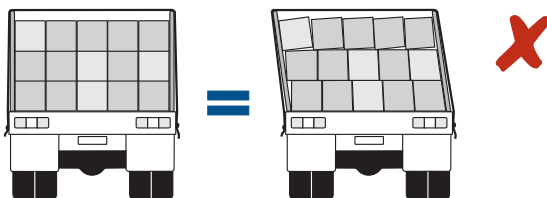


Fig. C.21

STACKED PACKS

If the load is stacked and the gates are braced with diagonal lashings from the top of each gate to the tie-rail on the opposite side, the gates can restrain the load (see Figure C.22).

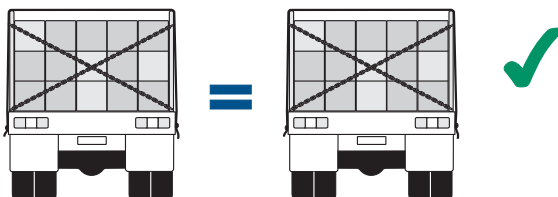


Fig. C.22

GATES CROSS TIED

If the load is a rigid and stable single layer, the gates can restrain the load (see Figure C.23).

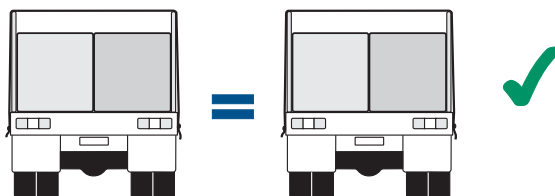


Fig. C.23

STABLE RIGID PACKS



Section C - Restraining Loads on Vehicles

If the load is tall and unstable the gates cannot prevent the load from tipping sideways (see Figure C.24).

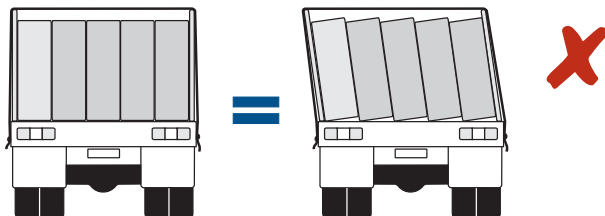


Fig. C.24

TALL UNSTABLE PACKS

Side gates can be strengthened by latching onto rigid drop-in stanchions placed between them.

The gates must be prevented from dislodging by locking pins or by lashing to the tie rails or by other means.

4.7 Pins, Pegs, Stanchions and Bolsters

Removable uprights such as pins, pegs and stanchions that are used for restraining loads must be restrained in position on the vehicle.

Loose fitting uprights that can dislodge on bumps and rough roads should be restrained directly by locking pins, attached chains etc. or indirectly using mounting sockets that are designed to be tight fitting.

4.8 Side Curtains

Side curtains on vehicles are generally used to protect the load from rain and dust and are usually quicker, easier and safer than a tarpaulin to put in place and secure.

A curtain is a thin, flexible sheet and even when reinforced with full-height webbing strapping, it can only resist sideways load movement if it deflects or bulges outwards (see Figure C.25). However, in some cases, a load shift that occurs can make the vehicle unstable and cause an accident. The bulging, particularly when the vehicle is stationary, can also make the vehicle wider than the maximum legal width.

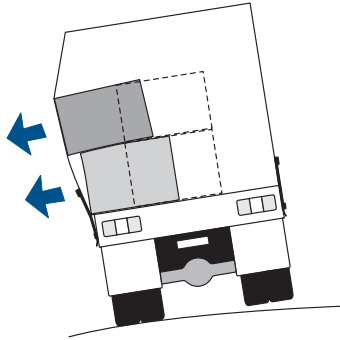


Fig. C.25 SIDE CURTAIN DEFLECTED BY LOAD SHIFT

The bulging of a curtain causes the curtain or straps to pull down on the roof and upwards on the coaming rails. The strength and flexibility of the roof, the top track and rollers, the curtain and straps and attachments are all critical to the load restraint capacity of a curtain. They are more effective when deflected at the bottom rather than halfway up because they adopt a greater angle to more directly resist the load shift.

Side curtains are often manufactured with two vertical straps, each having a lashing capacity of 750 kg, at each pallet position. Note that these straps do not provide a sideways restraint capacity of 1500 kg. Their capacity depends on their initial tension, the position of the load and the amount of load shift.

The following Figure C.26 illustrates a vertical strap bulged outwards by 100 mm and 275 mm at a position 300 mm above the deck. The sideways force that the strap can resist is shown compared to the tension to the strap (T). It can be seen that the sideways force is only 20% of the strap tension for the small (100 mm) bulge and 50% for the much larger 275 mm bulge.

In this case, the strap only stretches 0.3% when it bulges 100 mm. It is therefore unlikely to stretch enough to develop much more than its initial tension, which is usually much less than its lashing capacity.

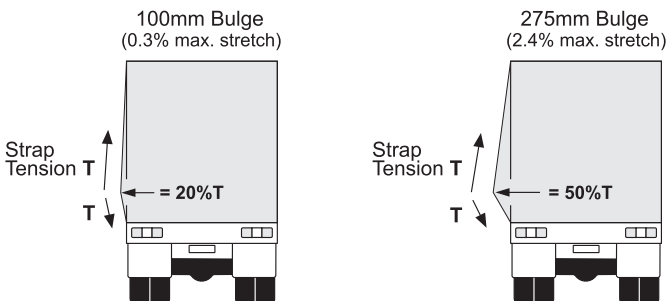


Fig. C.26 SIDE FORCE ON CURTAIN STRAP
300mm ABOVE DECK



Section C - Restraining Loads on Vehicles

Only curtains that have been certified in accordance with Section I (How to Certify a Load Restraint System), should be used for load restraint purposes. The certification (usually by the manufacturer) should specify whether gates must be used and the particular type of load including size, shape, weight and packaging. Certification of curtain-sided vehicles would normally require specialised technical resources and extensive testing.

A curtain-side without side gates may prove to be satisfactory as the only sideways load restraint system for a lightweight load that is fully packed inside the vehicle.

Curtains can be effective as a secondary restraint system for containing small lightweight individual items that can become separated from packaging and which would not tear/damage the curtain.

As a general principle, where the curtains are not certified for load restraint purposes, the load must be restrained as if the curtain did not exist, such as on an equivalent open flat top vehicle. Such loads (including part loads) should be tied down, or blocked or contained by other structures etc.

4.9 Tarpaulins

The main function of a tarpaulin is for weather protection.

Tarpaulins are useful for retaining loose bulk loads that might be affected by air flow. They can also act as a secondary restraint system where an item might become loose from a mixed load such as a loose can or bottle, provided the tarpaulin is in sound condition without tears or holes.

Tarpaulins must not be used as the sole restraint system unless specially designed and tested for the purpose.

Cap tarpaulins help to prevent some types of gates from lifting out of their mountings if the load puts pressure on an adjoining gate.

4.10 Tie Rails

Many tie rails are not strong enough for use with chain and webbing without bending. The forces obtained with this equipment can exceed the strength of the rails particularly when using direct restraint lashings.

The strongest points of a tie rail are where the cross-members attach to it. To avoid bending of tie rails, webbing should be attached at or near the support points.

4.11 Lashings

Synthetic ropes, webbing, and high-tensile steel chains are the most commonly used lashings. Steel strapping and wire rope have some limited applications. Ropes have low strength and cannot be tensioned sufficiently to restrain heavy loads.

Ropes and webbing are more elastic than chains or steel strapping. When a load deforms slightly or settles during transport, ropes or webbing will retain some of their initial tension. Relatively stiff chains or strapping may slacken completely.

Long lashings are more elastic than short lashings. They can absorb larger shocks without breaking.

Long lashings make it easier to obtain high tension consistently. The 'draw-in' length between each click of a webbing ratchet or each chain link with a 'dog' does not increase the tension as much as it does on a short lashing.

Chains or steel strapping should not be used to tie down loads that can crush or settle unless the lashings can be continuously retensioned during the journey.

A chain with a section of webbing to provide additional elasticity can be used where load settling occurs, eg. timber logs. The lashing can then be tensioned using a chain or webbing tensioner.

Ropes and webbing are more susceptible than chains to damage from sharp or abrasive loads and therefore require more protection. In addition, the sliding of webbing across an edge can cause heating from friction and subsequent failure.

Chains can cause damage where they contact a load unless a suitable protector is used between the chain and load.

4.12 Ropes

Rope designed for use in transport (Transport Fibre Rope) is made from synthetic fibre. Rope made from natural fibre has lower strength than synthetic rope.

All transport fibre rope with a diameter of at least 12 mm is colour-coded for its lashing capacity. A rope with two black marker yarns has a lashing capacity of 100 kg and a rope with one yellow and one black marker yarn has a lashing capacity of 300 kg. (Note these are the strength of the rope, not the tension achieved when tightening.)

Ropes should only be used for restraining relatively lightweight loads.

4.13 Webbing

Webbing assemblies comprise webbing, end fittings and tensioners. Tensioners can be either attached to the vehicle (truck winch) or 'in-line' (hand ratchet).

The standard webbing sizes include 25, 35, 50, 75 & 100 mm widths. The lashing capacity (LC) is displayed on each assembly that complies with the relevant Australian Standard. The 50 mm size is the most common one for road transport and has a minimum lashing capacity of 2000 kg. Webbing assemblies that do not comply with the Australian Standard can have much lower ratings. If using these assemblies, be sure to find out their rating.



Section C - Restraining Loads on Vehicles

4.14 Chain

Chains are usually fitted with hooks on each end and tensioned with 'over-centre' lever tensioners, commonly called 'dogs and chains'. The chain commonly used is 8 mm high tensile 'transport' chain with a typical lashing capacity of 3800 to 4000 kg. Other sizes are 6, 7.3, 10, 13 and 16 mm. All transport chain is marked at least every 500 mm with its lashing capacity (LC).

4.15 Strapping

Strapping can be steel or plastic material and is used for unitising loads into packs or bundles. Strapping can be highly pre-tensioned using manual or powered tensioners, making it very suitable as a tie-down lashing for heavy objects especially on container flats and pallets.

4.16 Stretch and Shrink Wrapping

Stretch film wrapping and shrink wrapping can be used to unitise a load consisting of many small objects such as palletised loads. They are often not suitable for heavier loads or loads with sharp corners that can penetrate the wrapping. The use of handling equipment can damage the wrapping and reduce its effectiveness.

4.17 Wire Rope

Wire rope is used to tie down loads that are placed cross-wise on the deck. The rope is tensioned with a winch or turnbuckle.

4.18 Elastic Straps

Elastic straps (octopus straps) are low strength lashings fitted with end hooks, commonly used for restraining lightweight equipment.

5 TENSIONERS

Ropes are normally tensioned using a single or double 'truckie's hitch' (see Figure C.27). The double hitch gives about twice the tension of a single hitch.

Each hitch has a multiplying effect like a 'block and tackle'. However, most of the applied tension is lost, because of the friction of the rope as it passes over itself in the knot and slowly becomes locked in the knot

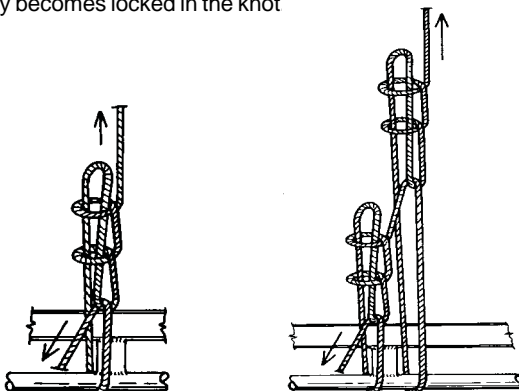


Fig. C.27 TRUCKIE'S HITCH (single & double hitch)

Webbing straps are tensioned using either attached clip-on, sliding winches or in-line tensioners. Geared winches are also available.

The attached 'truck winches' clip onto the tie-rails or slide into special tracks under the coaming rails (see Figure C.28).

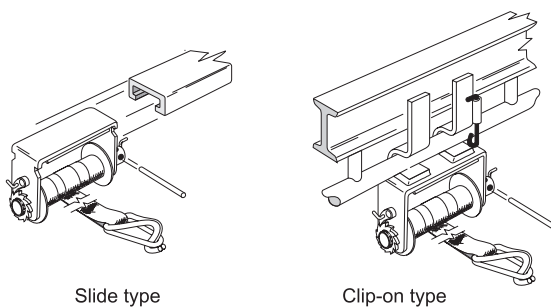
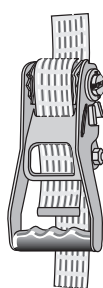


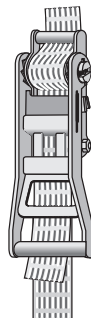
Fig. C.28 TRUCK WINCH

Section C - Restraining Loads on Vehicles

The 'in-line' tensioners can be either hand ratchet winches (see Figure C.29) or over-centre buckles that are attached to the tie rails, using a webbing strap and hook.



Push up to operate



Pull down to operate

Fig. C.29

HAND RATCHET WINCH

The amount of tension produced by a truck winch or hand ratchet depends on the length of the handle and how large the diameter of the webbing spool becomes during tightening. Hand ratchets that operate by pulling the handle downwards will normally produce much more tension than truck winches.

Higher tensions can be obtained by looping the strap over a standard triangular end fitting (see Figure C.30). The lashing capacity can be doubled and the pre-tension increased by an extra two-thirds.

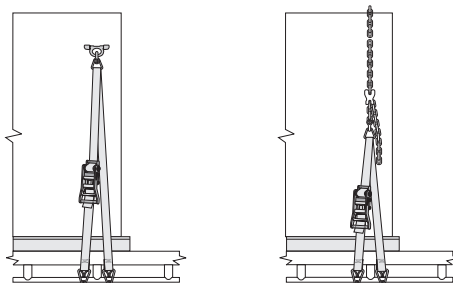


Fig. C.30

HIGH PRE-TENSION TIE-DOWN

This principle can be used for a combined chain and webbing system. (The loose end of any lashing should be positively secured on the vehicle to prevent contact with rotating wheels and unexpected wheel lock-up).

Chains can also be highly tensioned using turnbuckles or over-centre tensioners (also called ‘dogs’).

Fixed lever dogs can cause injury to the operator when applying or releasing the chain tension especially when standing on the load and also when using pipe handle extensions (‘cheater bars’). The use of these extensions is not approved by any manufacturer and can be dangerous.

Figure C.31 illustrates a fixed lever dog and a pivoting lever dog. When a fixed lever dog is released, the handle can rotate out of control releasing all the energy in the chain. If a cheater bar is used, it can be thrown off at high speed. The pivoting lever dog is designed to reduce the ‘kickback’ by limiting the lever movement.

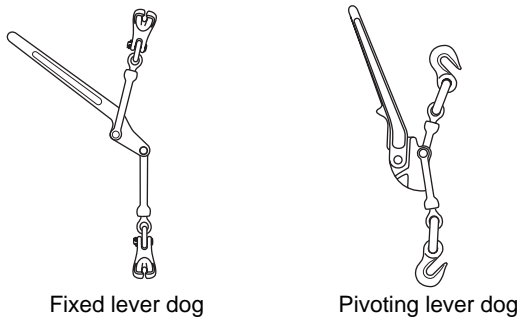


Fig. C.31 **OVER-CENTRE TENSIONERS OR ‘DOGS’**

Dogs are not suitable for tensioning short chains. This is because the chain link spacing can be greater than the stretch in the chain. The resulting chain tension could be much too low.

Turnbuckles are screw tensioners operated by either a ratchet or sliding lever (see Figure C.32)

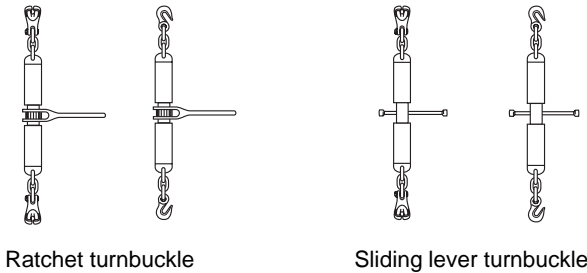


Fig. C.32 **TURNBUCKLES**

Turnbuckles have no kickback when released. Unlike dogs, very high tensions can always be achieved, even on short chains and without using handle extensions. If a turnbuckle does not rotate freely, it will cause the chain to twist and prevent it fully tightening.



Section C - Restraining Loads on Vehicles

6 USING LOAD-RESTRAINT EQUIPMENT

6.1 Attaching Lashings to Tie Rails

Where tie-down or direct lashings are attached to tie rails, they must be secured at or near the tie rail support points (see Figures C.33 & C.34). However, tarpaulin ropes can be attached to tie rails at any point in their length.

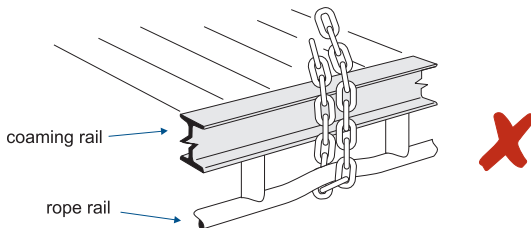


Fig. C.33

INCORRECT

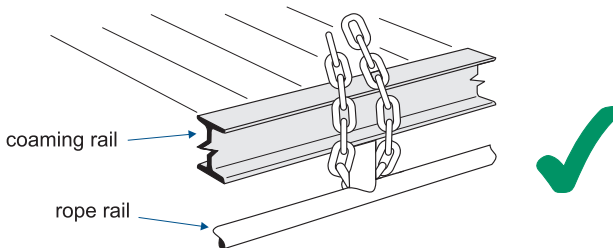


Fig. C.34

CORRECT (at support point)

Webbing straps should not be attached to tie rails by knots.

Hand ratchets and end fittings should not press against the coaming rail or the load because they might distort or bend.

Chain grab hooks are designed to attach to chain only. They must not be attached to coaming rail flanges or directly to the load unless specifically designed for that application.

6.2 Protecting Lashings and Loads

Corner protectors, sleeves or other packing material should be used where lashings and loads contact each other (see Figure C.35). Webbing straps and ropes can be easily cut on sharp edges.

Sharp edges and rough surfaces prevent the lashing tension from equalising on both sides of the load. Smooth rounded corner protectors enable high tension on both sides of the load thereby increasing load restraint.

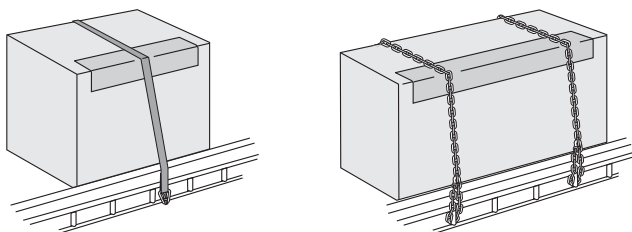


Fig. C.35 **LASHING AND LOAD PROTECTION**

6.3 Using Ropes and Knots

Ropes are attached to the tie rails and tensioned using knots. To be effective, the right knot must be used and correctly tied.

When tensioning a rope using a 'truckies' hitch, avoid injury by ensuring the rope does not break or cut on a sharp object or a knot does not slip and undo.

After a rope is tightened, the initial tension will usually relax after a very short time and the rope will need re-tightening.

Knots commonly used to attach and join ropes are illustrated in Figures C.36 and C.37.

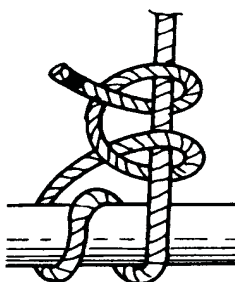


Fig. C.36 **ROUND TURN & TWO HALF HITCHES**



Section C - Restraining Loads on Vehicles

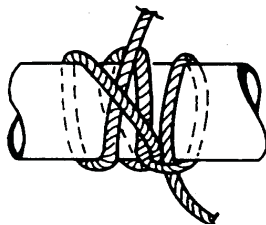


Fig. C.37

CLOVE HITCH & HALF HITCH

Both the above hitches are used to secure the end of a rope. The half hitch is used in conjunction with the clove hitch to provide added security. The clove hitch is also useful for attaching to a load in the middle of the rope, with each end attached to opposite tie-rails.

The sheepshank can be used to shorten a rope or to reduce the strain on a weakened section (see Figure C.38) by spreading the force among a number of pieces of rope in the centre of the knot.

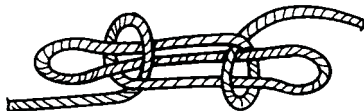


Fig. C.38

SHEEPSHANK

The single sheet bend can be used to join two unequal sized ropes (see Figure C.39).

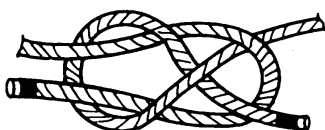


Fig. C.39

SINGLE SHEET BEND

6.4 Using Webbing and Tensioners

Webbing straps must always be protected when passing over sharp edges or rough surfaces.

Webbing straps must not be joined by knots or by any means unless approved by the webbing manufacturer.

Webbing assemblies must not be used with chemicals or at high temperatures without referring to the manufacturer's instructions.

When using truck winches, ensure the strapping is wound evenly across the drum, because the effectiveness of the winch decreases as the thickness of the layers of webbing increases. The decrease in effectiveness can be 100%.

When using hand ratchet winches, ensure there are at least 1½ turns of strapping on the spindle and no more than three, for effective pre-tensioning.

6.5 Using Chains and Tensioners

Any section of a chain under tension must not contain any knots and must not be attached to an anchor point using knots. The loose end of a chain however, may be secured to the vehicle using knots. Twisted chains should be straightened out before tensioning larger chains.

Chains must not be joined with wire or bolts or with joining links that do not match the lashing capacity of the chain assembly.

Chains must be protected over sharp edges or rough surfaces to maintain their full lashing capacity. The lashing capacity of the chain is reduced by 25% if the corner radius (R) is less than the chain size (D) (see Figure C.40).

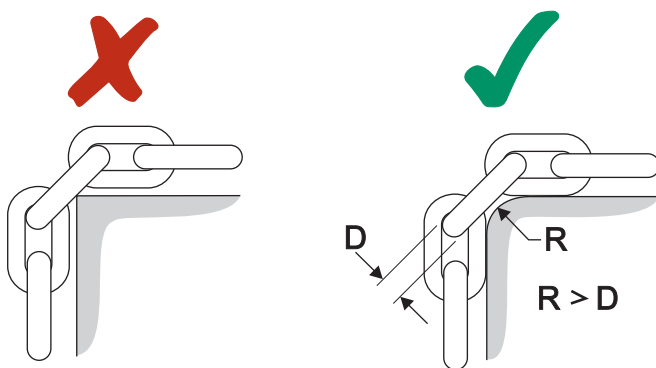


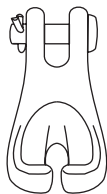
Fig. C.40

CHAIN OVER SHARP CORNER



Section C - Restraining Loads on Vehicles

There are two basic types of shortening hooks used on chains. These are the 'grab hook' (plain or 'winged') and the 'claw hook' (see Figure C.41).



Claw hook



Winged grab hook



Grab hook

Fig. C.41

CHAIN HOOKS

Plain grab hooks weaken a chain by bending the links they contact. Winged grab hooks prevent the chain link from bending and do not weaken the chain. The lashing capacity of a chain is reduced by 25% when using plain grab hooks.

Grab hooks are not designed for 'tip' loading and should only be attached to the matching size chain.

Claw hooks distribute the force evenly into the chain. Care should be taken when selecting equipment as some claw hooks will distort and fail before the chain breaks.

Hooks can become uncoupled if the chain slackens when the load settles during a journey. Some claw hooks have a shallow slot making them more likely to fall off.

When placed vertically, dogs must be positioned with the lever rotating downward to tension the chain.

The operator must ensure the lever is locked in the correct over-centre position and is not obstructed after tensioning the chain. If there is a possibility of the chain becoming loose because of a settling load, the lever must be secured to the chain by a tie wire, the loose end of the chain or other means.

When releasing a chain tensioned by a fixed lever dog, extreme care should be taken to prevent injury from the rotating lever that can release suddenly and unexpectedly.

Turnbuckles are suitable for tensioning chains, including short chains and those that are directly attached to the load. Some turnbuckles have a much higher strength rating than dogs and are suitable for tensioning larger chains.

NOTE:

- (i) 'Transport' chain is not suitable for lifting purposes and must not be used for any lifting or unloading.
- (ii) If chain is used for towing heavy vehicles, it must be thoroughly inspected after use and discarded if stretched or otherwise damaged. An 8 mm 'Transport' chain is not suitable for towing a prime mover with or without a semi-trailer attached.

6.6 Using Wire Rope and Winches

Wire ropes must be protected over sharp edges or rough surfaces to prevent damage. Sharp edges are those where the corner radius is less than the rope diameter.

Wire ropes must not be bent near a clamp or splice. The nearest bending point must be at least 3 times the rope diameter clear of the clamp end or splice.

Attachments and joiners must have a rated capacity at least equivalent to the lashing capacity of the wire rope. 'Commercial' grade and lower strength shackles are not suitable for applications using 12 mm or larger wire rope.

6.7 Using Tarpaulins

Tarpaulins should be secured to the vehicle so that any overlapping layers face rearwards to prevent penetration of wind or rain. Any torn tarpaulins or side curtains should be replaced or temporarily repaired to prevent further damage during a journey (see Figures C.44 & C.45).

When attaching tarpaulins, ensure any compulsory lamps, reflectors, number plates, rear marking plates etc. are not obscured, and any loose ropes or tarpaulin flaps are secured.

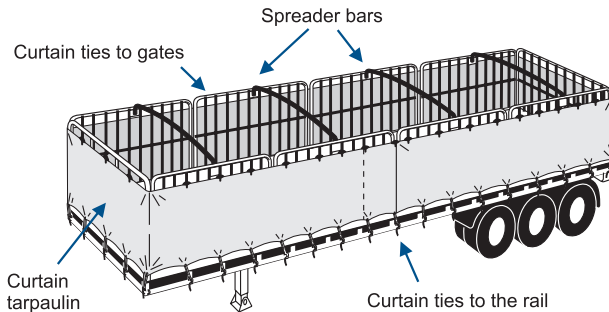


Fig. C.42

ATTACHING CURTAIN TARPULIN



Section C - Restraining Loads on Vehicles

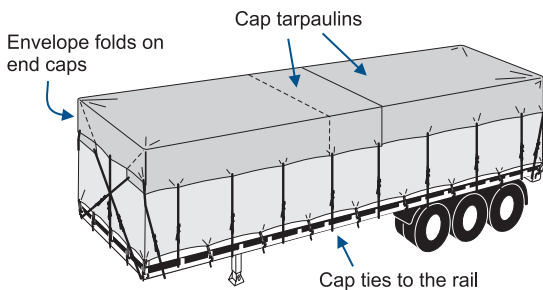


Fig. C.43

ATTACHING CAP TARPAULIN

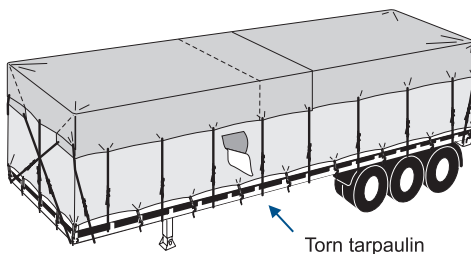


Fig. C.44

TORN TARPAULIN

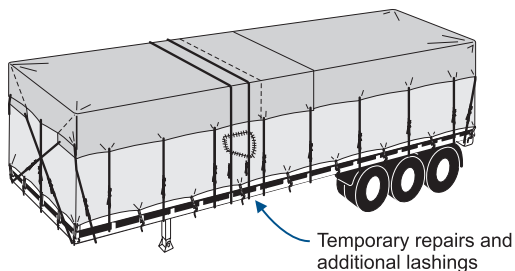


Fig. C.45

TEMPORARY REPAIRS



6.8 Using Elastic Straps

Be careful and avoid eye injury when using elastic 'octopus' straps. They can have considerable stored energy and are sometimes poorly constructed. The ends can pull off and hooks open up.

6.9 Storage of Equipment

All load restraint equipment such as, timber dunnage, lashings and tensioners, must be restrained on the vehicle or stored in lockers when not being used.

7 WEAR AND DAMAGE

Wear and damage on vehicle and restraint equipment can significantly reduce their strength and function. Equipment weakened beyond manufacturers' limits by cracked, broken and worn components must not be used for restraining loads.

All vehicle and restraint equipment must be inspected regularly, and if there is any doubt about their safety, they must be repaired or replaced.

All locking and latching mechanisms must be fully functional when being used for load restraint purposes.

Australian Standards state that lashings must be replaced if they are weakened by 10% or more of their original strength.

Further information on wear and damaged is described in Section H.



Section C - Restraining Loads on Vehicles

8 DOs AND DON'Ts

- DO** make sure you have enough lashings and that they are in good condition and strong enough to secure your load.
- DO** make sure that tie-down lashings are as near to vertical as possible.
- DO** make sure that direct lashings attached to loads on wheels are not near vertical.
- DO** attach lashings at tie rail support points.
- DO** check and re-tighten the lashings or other restraining devices as required.
- DO** use lashing protectors on sharp edges.
- DO** make sure that loose bulk loads cannot fall or be blown off your vehicle.
- DO** use a vehicle that is built strong enough for the job.
- DO** take extreme care when releasing a fixed lever dog and an elastic strap.

- DON'T** use faulty equipment.
- DON'T** attach chains between tie rail supporting points.
- DON'T** tie down loads onto greasy or dirty steel decks.
- DON'T** stand over and push down on a dog.



These ropes don't provide enough clamping force to adequately tie-down the steel gates on the steel deck.



A webbing net can be used for difficult loads.



The lightweight load (below) bent the front left-hand gate (above) almost to the ground).





The empty pallets, trolley and crate are unrestrained. A single rope is not sufficient to restrain this 700 kg pallet (see page 66).



It is bad practice to tie off chains using knots.



This is a tilt test of the friction between an unrestrained pack of steel tube and rubber load mat on timber dunnage. (The pack has a loose belly strap to control any sliding sideways). In this case, the weight of the load and the increased friction from the rubber provide 75% of the required restraint force. (Photo courtesy Regupol Safety Surfaces).



This aluminium headboard was not strong enough at the base to restrain this relatively low load. The headboard can easily be strengthened by bracing (see pages 73 & 74). (Photo courtesy Mick Simpson, Wales Truck Repairs).



The piece of dunnage chocking the base of these coils is an unrestrained load. All chocks and wedges should be positively restrained in position on the vehicle.



The sides on many vehicles are not high enough to restrain mixed loads such as builder's tools. They should be contained on a vehicle with a high-sided tray or cage.



This photo shows a curtainside with a severe hernia. The load shifted on a corner. *(Photo courtesy Mick Simpson, Wales Truck Repairs).*



A bulge in a curtain can indicate that an unrestrained load is inside. The truck might also exceed the maximum width limit of 2.5 metres.



These photos show what happens to an unrestrained load in a curtain-sided trailer when it rolls over. *(Photos courtesy Mick Simpson, Wales Truck Repairs).*



A curtainside trailer after an accident. (Photo courtesy Mick Simpson, Wales Truck Repairs).



The driver was unaware that this new 1800 kg press, still in its plastic wrapping, had broken through a side curtain and fallen on the roadside. The press should have been tied in the trailer, with lashings arranged to stop it tipping over.



These pallets are unrestrained because there is no rear gate to prevent them dislodging from the rear of the vehicle.



This trolley is unrestrained because it could dislodge through the gap between the side gates.



These rolls of turf are not restrained. Soft compressible loads like these are difficult to restrain by tie-down, because the load will settle and the lashings will loosen. They should be contained on the vehicle using sides or gates.



Three ropes are not adequate to restrain this 3800 kg load of timber (see page 66).



The ropes on the cardboard boxes can't provide enough restraint for the steel star posts underneath. The posts should be lashed separately.



All loose items on the deck must be restrained, including the 'witch's' hats and toolboxes. These items are best contained on the vehicle using high sides or a special enclosure.



All skips must be restrained, whether empty or full. The hydraulic lifting frame should not be considered as a part of the restraint system, unless equipped with positive locking features.



A 330 kg bronze block (see inset photo) fell off one truck and went completely through the front of the truck shown above, severely injuring the driver. If both trucks were travelling at 100 km/h in opposite directions, the block's impact speed would have been about 200 km/h.



This shows some aluminium ingot packs that have tipped forwards under heavy braking. Note that the webbing tie-down straps have stretched and allowed the load to tip over. The unbraced front load rack was too weak to support the front pack.



A piece of carpet can be used to protect a webbing strap over a sharp edge.



SECTION D

DRIVING LADEN VEHICLES

CONTENTS	
1 VEHICLE DYNAMICS	107
2 CHECKING THE LOAD	108
3 HIGH AND WIDE LOADS	108
4 DOs AND DON'Ts	108



Section D - Driving Laden Vehicles

This Section describes how the driver of a laden vehicle can ensure its safety by safe driving and correct load restraint. It includes the following:

- Vehicle Dynamics
- Checking The Load
- Do's and Don'ts

The following are your responsibilities:

- It is the responsibility of the driver to take into account the effect of the load on the steering, cornering and braking performance of a laden vehicle.
- It is the responsibility of the driver to periodically check to ensure the load remains properly restrained during a journey.

Truck drivers should refer to the '*Australian Truck Drivers Manual*' (see Section J), for a comprehensive guide to safe driving of load carrying vehicles.

The following requirements relate only to the effects of the load and its restraint on the safe driving of laden vehicles.



1 VEHICLE DYNAMICS

Loads can vary significantly in weight, size, shape and distribution on the vehicle. Different loading combinations can cause large variations in the way a vehicle drives.

The driver of a laden vehicle must take into account any changes in the vehicle's stability and steering and braking caused by the type of loading on the vehicle.

Steering and cornering can be affected by the weight and distribution of the load, and the vehicle's speed.

Vehicles carrying high and 'live' loads are more likely to overturn on corners, especially if the corners are cambered the wrong way. 'Live' loads include bulk liquids, livestock, hanging meat, wet concrete, motor vehicles and large rubber-tyred equipment.

High wind speeds, which can occur on high bridges, in valleys and between high buildings, can reduce vehicle stability or blow the load off.

Braking performance is affected by the weight of the load and its distribution. When axles are lightly loaded, wheel lock-up and skidding can occur. This reduces braking efficiency and steering ability.

The braking forces can be greater at low speed than at high speed because of the grabbing or 'spike' effect at low speed.

Drivers should travel slower during cornering and on rough roads, where increasing speed increases the forces that cause the load to shift.

When a vehicle turns a corner its 'swept-path' on the road surface is wider than its actual width. Generally, the longer the vehicle combination, the wider the swept-path.



Section D - Driving Laden Vehicles

2 CHECKING THE LOAD

During a journey, some loads can settle and shift. Lashings can loosen and objects can fall off.

During a journey the driver must periodically check such loads and lashings to ensure that the load does not fall off. The amount of checking required depends on many factors, including the type of load, the type of restraint system, the roughness of the road and how well it is packed.

In practice, some loads require the lashings to be checked and re-tensioned after only a very short distance. A few kilometres might be too late for some loads, whilst others require checking only during routine vehicle stops. Drivers must become familiar with the characteristics of the load and know how often to check the load during a journey.

3 HIGH AND WIDE LOADS

Make allowances for high and wide loads when driving around corners, under bridges, under electric cables, near power poles, traffic lights and other obstructions.

4 DOs AND DON'Ts

- DO** remember that the size, type and position of your load will affect the handling of your vehicle.
 - DO** remember that loads can settle and shift during a journey, causing lashings to slacken.
 - DO** check your load before moving off.
 - DO** check your load every time an item is added or removed during the journey.
 - DO** check your load periodically and at routine stops.
 - DO** check your load after emergency braking or swerving.
- DON'T** take risks.



Two ropes and the pipe loading rack in front won't restrain this load of tiles and batters.



The side curtain could not restrain these pallets of cooking oil.



This load required more than plastic wrapping and a tarpaulin to restrain it on the trailer.



A metal pipe fitting dislodged from a vehicle and hit the bonnet and roof of this car.
(Photo courtesy Beaudesert Times)



Lengths of timber slipped sideways after the load had settled on packing strips that separated the timber. (Photo courtesy Queensland Transport).



The product is well contained in the crates, but the crates aren't restrained on the truck. (Photo courtesy John Brentnall).



Bulk bags must be restrained. Tie-down is seldom effective because the contents can settle during a journey and allow the lashings to loosen. Containing the bags on the vehicle with properly designed sides or gates is a better option. *(Photo courtesy John Brentnall).*



This inadequately restrained 12 tonne stainless steel coil rolled forward onto the chassis, over the top of the unbraced loading rack. The extra weight caused a front tyre to burst.



These slabs of broken concrete could easily fall from the tipper. The base of each item of load should be well below the top of the sides to ensure that it won't dislodge on bumps or rough roads.



This load of broken tiles is higher than the sides and is therefore not properly restrained. In such cases the load should be covered with a strong tarpaulin or cargo net designed to prevent any small piece of the load from dislodging from the vehicle.



This crane stabilising leg, which was not locked in position, slid out and collided with a parked car, pushing it into a suburban front yard (see photo inset). In this case, the stabilising leg was considered to be an unrestrained load.



Remember to use the stabilising legs when using the crane for loading or unloading. The weight of the load on the crane arm has overbalanced the truck. *(Photo courtesy Mick Simpson, Wales Truck Repairs).*



Loads must not cover number plates, lights and reflectors.



These concrete pots had no restraint at all! (Photo courtesy John Brentnall).



The tracked excavator hit a power pole and slid off the trailer. When carrying high or wide loads always allow for the extra clearance needed to clear obstructions.



Load restraint accidents can happen at any speed. Note the 60 km/h speed sign in the centre of the photograph and in the photo insert.

SECTION E

LOADS



CONTENTS	
1 GENERAL FREIGHT	119
1.1 Dangerous Goods -----	119
1.2 International Cargo Symbols and Signs and Dangerous Goods Class Labels -----	120
2 PACKS AND PALLETS	121
2.1 Unitising -----	121
2.2 Packs -----	121
2.3 Loads on Pallets -----	122
2.3.1 Unitised load resting on pallet -----	122
2.3.2 Unitised load secured to pallet -----	122
2.3.3 Load loosely secured to pallet -----	122
2.4 Restraining Packs and Pallets -----	122
2.5 Unitising Tall Items -----	124
3 ROLLS, REELS, COILS AND DRUMS	125
3.1 Positioning -----	125
3.2 Restraining Rolls, Reels, Coils and Drums -----	126
3.2.1 Vertical rolls, reels, coils and drums -----	126
3.2.2 Horizontal rolls, reels, coils and drums -----	127
3.2.3 Coiled rod -----	127
4 PIPES, TUBES, LOGS, RODS, BARS AND BILLETS	128
4.1 Pipe and Round Lengths on Scalloped Dunnage -----	129
4.2 Cradled Pipes -----	129
4.3 Loose Lengths Between Stanchions -----	130
4.4 Pipes and Round Lengths on Flat Dunnage -----	131
4.5 Unitised Large Diameter Pipes, Bars and Billets -----	132
4.6 Long Lengths -----	134
4.6.1 Flexible long lengths -----	134
4.6.2 Rigid long lengths -----	134
4.7 Short Pipes and Logs -----	135
5 SHEETS AND FLAT LOADS	137
5.1 Sheet and Flat Plate -----	137
5.2 Empty Pallets -----	137
6 BALES, BAGS AND SACKS	138
6.1 Bales -----	138
6.2 Bags and Sacks -----	139
7 CONTAINED LOADS	140
7.1 Loose Bulk Loads -----	141
7.2 Loose Individual Loads -----	144
7.3 'Live' Loads -----	144



8	LARGE LOADS	145
8.1	Containers -----	145
8.1.1	Shipping containers -----	145
8.1.2	Tanks, bins and skips -----	148
8.1.3	Bladders and flexible tanks -----	149
8.2	Portable Buildings -----	151
8.3	Large Castings and Fabrications -----	151
9	VEHICLES AND MOBILE EQUIPMENT	152
9.1	Selection of Carrying Vehicle -----	152
9.2	Load Requirements -----	152
9.2.1	Lashing points -----	152
9.2.2	Articulated vehicles -----	153
9.2.3	Moveable parts and attachments -----	153
9.2.4	Controls -----	153
9.2.5	Height -----	153
9.2.6	Tyres -----	153
9.2.7	Wide loads -----	153
9.3	Tie-down and Direct Restraint -----	154
9.3.1	Tie-down -----	154
9.3.2	Direct restraint -----	154
9.3.3	Combined tie-down and direct restraint -----	154
9.4	Lashings -----	155
9.5	Attaching Lashings -----	156
9.6	Restraining Tracked Equipment -----	157
9.7	Restraining Rubber Tyred Vehicles and Equipment -----	162
9.7.1	Rubber tyre bouncing -----	162
9.7.2	Small equipment -----	164
9.7.3	Motor vehicles -----	165
9.7.3.1	Wheel restraint -----	165
9.7.3.2	Tie-down -----	165
9.7.3.3	Direct lashing -----	166
9.7.4	Large equipment -----	166
9.8	Suggested Methods of Restraining Mobile Equipment, Trailers and Other Vehicles -----	167
9.8.1	Tracked excavator -----	167
9.8.2	Dozer or track loader -----	167
9.8.3	Restraining a wheel loader -----	168
9.8.4	Restraining a grader -----	168
9.8.5	Restraining a roller -----	169
9.8.6	Restraining a forklift -----	169
9.8.7	Restraining caravans and small trailers -----	170



This Section contains additional information on the restraint of particular commodities and items of load.

Specific approved guidelines may be available for the restraint of many products from industry associations and/or product manufacturers. These guidelines will most likely contain greater detail than can be included in this guide. When using these guidelines always ensure they have been certified by an engineer or have been tested to meet the "Performance Standards".

1 GENERAL FREIGHT

General freight normally comprises a combination of different types of load which can vary considerably in mass, size and shape. General freight can comprise a large number of small items including boxes, cartons, crates, bags, drums, and plastic containers, but often includes large items such as, pallets, steel coils, and machinery.

Where there is a wide variation of load types, it is often easier to contain the load than tie-down every item. It is preferable to ensure that movement of loads is prevented. In cases where movement has been allowed for, the movement must not cause vehicles to become unstable or the load to dislodge. Bodies suitable to contain general freight include vans, pantechnicons, and bodies fitted with sides or gates.

Separate lashings should be used for large individual loads, which cannot be effectively contained.

Rope is not strong enough to adequately restrain heavy loads.

Care should be taken when restraining soft loads such as cartons, because the lashings will loosen if they cut through or distort the load.

Where parts of the load are added or removed during a journey, the load must be rearranged and restrained where necessary, at each stop, to maintain correct load distribution and restraint.

1.1 Dangerous Goods

The requirements of this Load Restraint Guide apply to loads of dangerous goods as they do to all other loads. However, there may be additional load restraint requirements for certain dangerous goods, such as gas cylinders, imposed by 'The Australian Code for the Transport of Dangerous Goods by Road and Rail'.

Consignors, loading staff, drivers and operators involved in the transport of bulk and packaged dangerous goods must be familiar with the special requirement of this Code (listed as a referenced document in Section J of this Guide).

Section E - Loads

1.2 International Cargo Symbols and Signs and Dangerous Goods Class Labels

Many loads, especially international cargo and dangerous goods, are marked with symbols indicating special handling information and instructions (see Figure E.1). The class labels shown in Figure E.1 are some examples of class labels however they do not constitute all class labels.

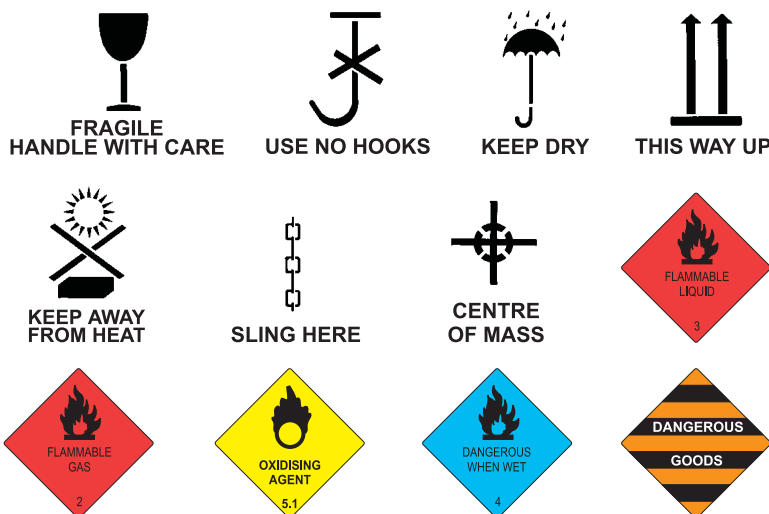


Fig. E.1 **SAMPLES OF INTERNATIONAL CARGO SYMBOLS AND DANGEROUS GOODS CLASS LABELS**

If a dangerous goods class label is present there may be additional load restraint requirements specified in the *Australian Code for the Transport of Dangerous Goods (Road and Rail)*.

International cargo symbols are normally black and between 100 mm and 200 mm high. Several different symbols may appear on each load to indicate a number of instructions.

The symbols are normally placed in the upper left and right-hand corners of the main vertical face of the load and, if possible, are repeated on the other vertical faces.

'**SLING HERE**' and '**KEEP AWAY FROM HEAT**' symbols are, however, usually placed on the lower vertical face of the load.



2 PACKS AND PALLETS

The following contains information on restraining loads that are bound into packs or stacked on pallets.

2.1 Unitising

Items of load can be bound together to form a single unitised load to make them easier to handle and restrain.

Unitising methods include banding, strapping, gluing, stretch wrapping and shrink wrapping.

Consignors of unitised loads should ensure that the size of the packs and the unitising method is appropriate to restrain individual items in the pack during transport. If the unitising fails during transport, the load can dislodge from the vehicle.

Because pack strapping is tensioned from the top, the base of the pack may not be effectively consolidated. It is therefore important that the assembly and strapping system used ensures that the bottom layers are tightly packed.

2.2 Packs

Packs can comprise multiple layers or stacks of material, or bundles of individual lengths.

Packs may be restrained by tie-down or containment.

Unitising on its own may not be sufficient to restrain all items in a pack during transport.

Layers can slide within a pack because of slippery surfaces or particles between the layers.

Individual lengths can spear out from the centre of a pack because the external strapping does not clamp all of the internal tubes. In rectangular packs, the strapping forces often only clamp the outer lengths of the pack. In such cases spearing can be prevented by end wrapping or blocking.

When bundling lengths, especially circular items, the strapping will cause the pack to form a circular shape. Generally if the lengths are initially strapped in any other shape, external forces could cause the bundle to change shape and the strapping to loosen. The exceptions are triangular packs of three circular sections and hexagon packs of seven circular sections.

Individual items can become dislodged from a stack on a pallet because the strapping forces are not evenly spread throughout the pack. Items often become dislodged from the upper outer edges of an inadequately unitised pack.

Where there is a possibility that items can dislodge from a pack, additional restraint (by blocking or containment) must be used.



Section E - Loads

Some packs are an unstable shape for restraint in the forward direction (for example, ingots, bricks). These packs must be prevented from tipping forward by placing them against barriers or other packs or by other methods .

2.3 Loads on Pallets

2.3.1 Unitised load resting on pallet

Where unitising is not sufficient to restrain the product on the pallet during transport, the product requires restraint as well as the pallet.

If the pallet is restrained by tie-down, the combination of the unitising and tie-down must prevent all items on the pallet from becoming dislodged. If an item could dislodge, additional restraint must be used.

2.3.2 Unitised load secured to pallet

Where the items of load are adequately unitised and secured to the pallet, the load can either be tied down or contained.

2.3.3 Load loosely stacked on pallet

Items of loads loosely stacked on a pallet can be restrained completely by containment by the vehicle structure (for example gates, headboards, racks) or other parts of the load.

Alternatively, external tie-down lashings can be used provided all parts of the load are restrained by the lashings. If the lashings cannot restrain every item, the load must be restrained by the vehicle structure or other parts of the load.

2.4 Restraining Packs and Pallets

Packs and pallets can be restrained by combinations of tie-down and blocking, or in some cases, by direct restraint (headboards and gates) only.

Tarpaulins and curtain sides alone should never be considered as a total pallet restraint system, unless they have been specifically designed and certified for the particular type of load.

Tie-down lashings over the top of packs and pallets can readily provide the necessary rearward and sideways restraint, in most cases. However, to reduce the number of tie-down lashings to a practical number for forward restraint, the front of the load can be blocked.

The use of rubber load mat can greatly reduce the number of tie-down lashings required especially for loads with slippery surfaces (see Figure E.2). Packs of hollow sections can be restrained using timber dunnage with rubber load mat bonded to the top and bottom surfaces provided sparring of the hollow section from within the pack is prevented.

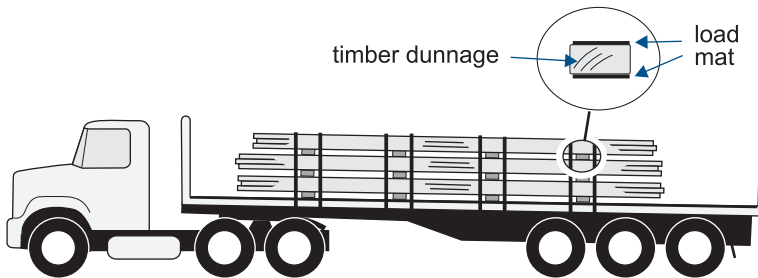


Fig. E.2 **RESTRAINING BUNDLES OF HOLLOW SECTIONS**

Additional restraint can be provided by blocking the full pallets with an empty pallet against a headboard or loading rack (see Figure E.3) provided items placed on each pallet are tied down to the pallet in a way that means the performance standards are met, or restraining the headboard or rack with direct lashings (see Figure E.4).

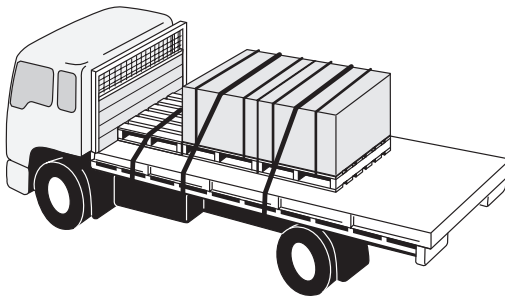


Fig. E.3 **PALLET BLOCKED AGAINST HEADBOARD**

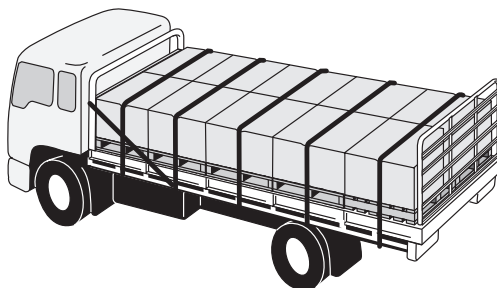


Fig. E.4 **PALLETS BLOCKED AGAINST HEADBOARD**

Where the product on the laden pallet has sufficient strength and rigidity, the pallets can be stacked two high and restrained by blocking against the headboard or loading rack, and using tie-down.

Where laden pallets are restrained by tie-down, every separate pallet or every row of pallets across the load must be restrained by at least one lashing (see Figure E.4).

Where a laden pallet is partially restrained by tie-down lashings and cannot be blocked in the forward direction, the use of direct lashings applied through or around the base of the pallet can provide additional restraint. Direct lashings through the base of a pallet must not be used as the only form of restraint if the load is not adequately secured to the pallet.

Information in Section C.2 and Section F.3 shows that ropes are not suitable for restraining pallets weighing more than 0.5 tonne. Where the pallet is not blocked, a single rope cannot even restrain a single empty pallet. Webbing (or chain assemblies) with a lashing capacity of at least 2 tonnes should be used for restraining pallets weighing more than 0.5 tonne.

2.5 Unitising Tall Items

Tall items can tip over under heavy braking or cornering. When cornering, this can happen if the height of the load is twice, or more, than the length of its base (measured in the sideways direction). When braking, this can happen if the height of the load is only one and a quarter times or more, than the length of the base (measured in the forward direction). See Section B.3 for more information on recognising unstable loads.

Tall items can usually be unitised into a stable shape by strapping three or more items together.



3 ROLLS, REELS, COILS AND DRUMS

The following contains information on restraining cylindrical loads, such as rolls, reels, coils and drums.

Because of their shape, rolls of paper, newsprint, cardboard, plastic, etc. and reels of cable, rope, etc. should be transported wherever possible on specially equipped vehicles or in containers.

Large rolls or reels are generally restrained individually on a vehicle, whereas small rolls and reels can be effectively secured on pallets or restrained by containment in suitable bodies or containers.

When sheet coils are carried with the bore horizontal they should be wrapped or strapped to prevent 'telescoping' during transport. Telescoping can cause vehicle instability and loss of load.

3.1 Positioning

Rolls, reels and drums can be transported horizontally (on their side), or vertically (on their end). Horizontal rolls, reels and drums can be laid either along or across the vehicle.

Where the length of a cylinder is less than its diameter, it should be placed on end for transport (if allowed by the manufacturer).

Where the length of a cylinder is greater than its diameter, its positioning should take into account whether the cylinder is supported by a vehicle structure or by another part of the load to prevent it from tipping.

Tall cylinders may be carried vertically, for example by lashing to a headboard or by nesting in the centre of a tightly packed mixed load.

Where several rolls, reels or drums are transported together, they should be packed together to prevent movement and where weight distribution permits, they should be placed against a headboard or bulkhead (see Figures B.19, B.20).

When transported on their side, individual rolls and reels should be placed on fixed or movable cradles to prevent them from rolling. Chocks or wedges must be individually restrained to prevent movement during transport.

Cradles also protect the load and help to distribute the weight over the vehicle's deck. The minimum recommended wedge angle for cradles and chocks is 39 degrees (see Section G.7).



Section E - Loads

3.2 Restraining Rolls, Reels, Coils and Drums

Rolls, reels, coils and drums can be restrained by combinations of tie-down, blocking against headboards, gates and coaming rails and in some cases, direct restraint.

Rolls, reels, coils and drums that are not blocked or contained by vehicle body structures (or by other items of load) require separate lashings to prevent movement in all horizontal directions.

Tarpaulins and curtain sides alone should never be considered as a total restraint system.

Tie-down lashings over the top of rolls, reels, coils and drums can readily provide the necessary rearward and sideways restraint, in most cases. However to reduce the amount of tie down lashings required to a practical number, additional restraint may be required to prevent forward movement.

Additional restraint can be provided by blocking the roll, reel or drum against a headboard or loading rack (see Figure B.19) or by restraining it with direct lashings.

The use of rubber load mat can greatly reduce the number of tie-down lashings required.

Angled edge corner protectors (see Figure E.5) or specially fabricated core inserts (see Figure E.6) should be used to prevent damage to the load and to prevent the lashings slipping sideways.

3.2.1 Vertical rolls, reels, coils and drums

When transported on their end, rolls, reels, coils and drums should be lashed to the deck to increase frictional restraint and if necessary, blocked to help prevent forward movement or completely contained.

Unless unitised on a pallet or contained in a suitable body or container, every roll, reel, coil or drum should be restrained on the vehicle by at least one lashing (see Figure E.5).

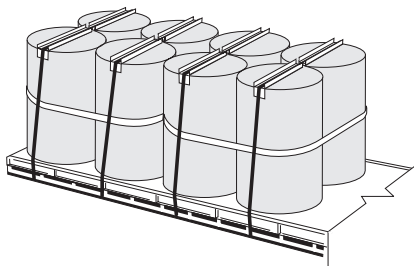


Fig. E.5

RESTRAINING VERTICAL ROLLS

Some webbing straps may not be suitable for restraining tall, unstable rolls, because of excessive stretch in the webbing. The stretch can be up to 13% of their length at the lashing capacity.

3.2.2 Horizontal rolls, reels, coils and drums

Where movable cradles are used, they should be restrained by a combination of blocking against headboards or coaming rails and by tie-down.

Rolls, reels, coils and drums should be restrained by wedges or chocks to prevent rolling during loading and unloading.

Where horizontal rolls, reels and drums are stacked, inter-layer packing material should be used to increase the friction where surfaces are slippery.

Lashings should be applied so there is a downward clamping force on all items of load to provide adequate sideways restraint, and to prevent rolling movement.

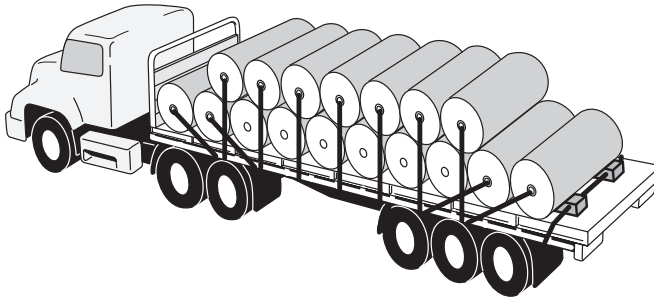


Fig. E.6 **RESTRAINING LARGE DIAMETER ROLLS**

3.2.3 Coiled rod (sometimes called rod-in-coil)

Large numbers of coils of metal rod should only be transported on vehicles with purpose-built structures or with tie-down systems specifically designed to restrain this type of coils.

The horizontal loading (these coils must never be stacked on top of each other) of large numbers of vertical coils of metal rod, in-line along the length of the vehicle deck, without the use of special cradles, is not recommended.

Coils of metal rod can be transported by restraining each one separately by lashing passed through the bore or containment.

Individual coils, lying on their side on timber dunnage, may be restrained by tie-down lashings and blocking.

Individual coils may also be restrained by containment.



4 PIPES, TUBES, LOGS, RODS, BARS AND BILLETS

The following contains information on restraining cylindrical loads, such as pipes, tubes, logs, rods and round bars and billets.

Round pipes are manufactured in various forms, including metal and plastic in long lengths and reinforced concrete in short lengths. Logs can be either long or short lengths.

Where large quantities are regularly transported, specialised methods and equipment, such as scalloped dunnage, unitised bundles or containers should be used. This can significantly reduce transport costs, product damage and loading/unloading time. It can also ensure the level of restraint will comply on every journey.

Lengths with smooth surfaces are difficult to restrain using tie-down. The friction between individual sections can be substantially increased by using inter-layer packing material, such as timber or rubber matting.

Because of large manufacturing tolerances, pipes in a load may have diameters so different, that individual pipes may not be effectively clamped by the external lashings. In such cases the loose pipes must be individually retained.

Many pipes have spigoted, socketed, threaded, bevelled or flanged ends for joining and sealing. To ensure these ends are not damaged during transport, suitable packing material should be used.

Damage to soft or crushable loads can be prevented by the use of webbing lashings or appropriate protectors for ropes, chains and lashing hardware.

Consignors should ensure the size of bundles and the strapping is appropriate to restrain all lengths and prevent any length from sliding out of the pack.

4.1 Pipe and Round Lengths on Scalloped Dunnage

Dunnage which is scalloped top and bottom (see Figure E.7) or on the top only, can be designed to prevent pipes rolling during transport and during loading and unloading. Scalloped dunnage is only effective if the scallop is deep enough to stop the pipe rolling sideways.

Where a load on scalloped dunnage is tied down, side stanchions are not required either for load restraint or for loading and unloading. Note that the load is 'crowned' so that all pipes have a downward force provided by the lashings. If crowning is not used, the middle, upper two pipes are not restrained and could fall off.

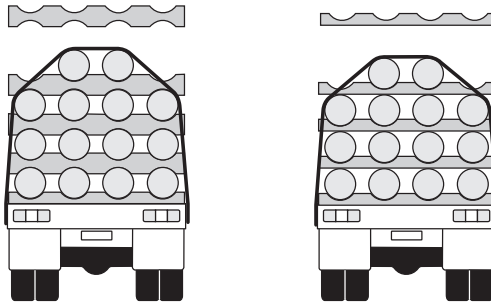


Fig. E.7

SCALLOPED DUNNAGE

4.2 Cradled Pipes

Large diameter pipes should be tied down on specially fabricated cradles that prevent rolling and distribute the weight evenly over the vehicle (see Figure E.8). Care should be taken when driving with loads that have a high centre of mass.

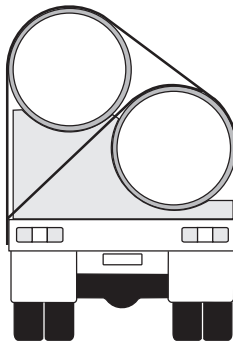


Fig. E.8

CRADLED PIPES

To prevent pipes rolling sideways, the dimensions of scallops and cradles should be determined in accordance with Section G.7.



Section E - Loads

4.3 Loose Lengths Between Stanchions

Stanchions are used to restrain a load sideways. Forward and rearward restraint is by tie-down.

The stanchions can either be fixed, pivoting or removable. Pivoting (drop) stanchions are designed to allow self-unloading. The stanchions must be strong enough to provide the required sideways restraint for the whole load.

At least two stanchions should be used on each side of the vehicle, to prevent the tendency of the load to spread sideways. In addition, every length in a load must be restrained by a minimum of two stanchions.

Where only two pairs of stanchions are used, the outer ends of the outside lengths should extend at least 300 mm beyond the stanchions. Longer lengths should be placed on the outside of the stack and shorter lengths in the centre.

The top of each outside length should be no higher than the stanchion. The top middle lengths should be higher than the side lengths so as to 'crown' the load and allow proper clamping of each section of the load by the tie-down lashings (see Figure E.9).

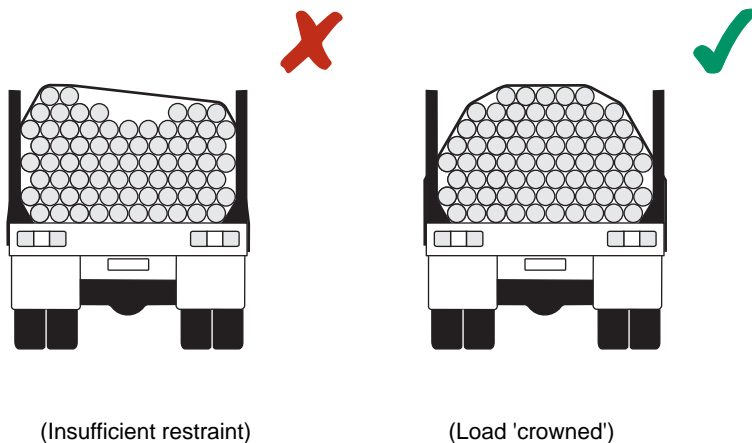


Fig. E.9

LOOSE LENGTHS BETWEEN STANCHIONS

4.4 Pipes and Round Lengths on Flat Dunnage

Where pipes are tied down on flat dunnage, side stanchions (see Figure E.10) are required to prevent the pipes rolling during loading and unloading.

Where tie-down lashings pass over each layer of pipes, they can prevent all the pipes in that layer from rolling. If there is sufficient tie-down, side stanchions do not need to be designed to provide sideways restraint when the vehicle is moving.

In such cases, the strength of the stanchions should be based on the loading and unloading forces (which should take into account impacts from loading and unloading equipment).

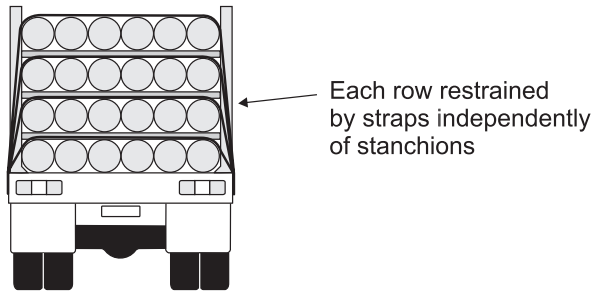


Fig. E.10 **STANCHIONS FOR LOADING & UNLOADING**

Where tie-down lashings do not prevent the pipes in each layer from rolling, the side stanchions (see Figure E.11) must be strong enough to provide the required sideways restraint for each layer of pipes.

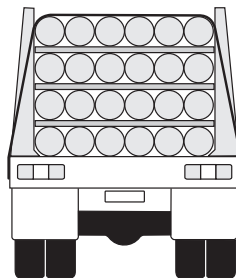


Fig. E.11 **STANCHIONS PROVIDING SIDEWAYS RESTRAINT**



Section E - Loads

4.5 Unitised Large Diameter Pipes, Bars and Billets

To prevent large diameter pipes rolling and make them easier to restrain they can be unitised using steel or webbing 'belly strapping' (see Figure E.12) or 'belly wrapping' (see Figure E.13) the lashings. Bars and billets can also be restrained using these methods. Note that these systems rely on friction between the products and are not suitable for slippery and crushable lengths.

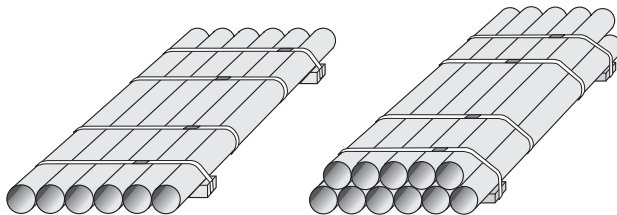


Fig. E.12

BELLY STRAPPING

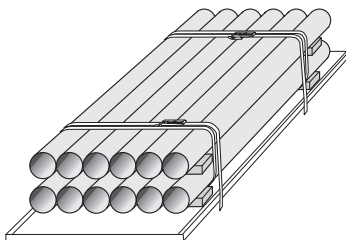


Fig. E.13

BELLY WRAPPING

When belly wrapping, the lashings must be looped over the top of the load to provide tie down. If the lashings are looped underneath a rounded load, they will not prevent it from rolling (see Figure E.14).

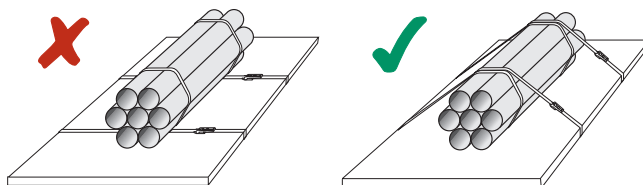


Fig E.14

BELLY WRAPPING ROUNDED LOADS

Small quantities of loose lengths can be unitised and restrained by at least two lashings looped around the bundle and secured on both sides of the vehicle.

Steel or plastic strapping can be used to attach pipes to dunnage for ease of handling. Where the strapping passes under the dunnage, the dunnage should be slotted to prevent the slippery strapping contacting the deck. This could allow the load to slide on the slippery face of the strapping.

When restraining unitised loads they should be kept as low as possible, with smaller sections placed on top. No layer should be larger than the one below it.

Where the load comprises a number of odd sized bundles it should be 'crowned' to provide even downward pressure. Alternatively, each layer should be lashed together to form a single unit using 'belly lashings' and tie-down lashings then applied over the top of the load.

In some cases it may be necessary to divide the load into two or more stacks to crown it effectively (see Figure E.15). This can be achieved by attaching the lashings along the middle of the deck.

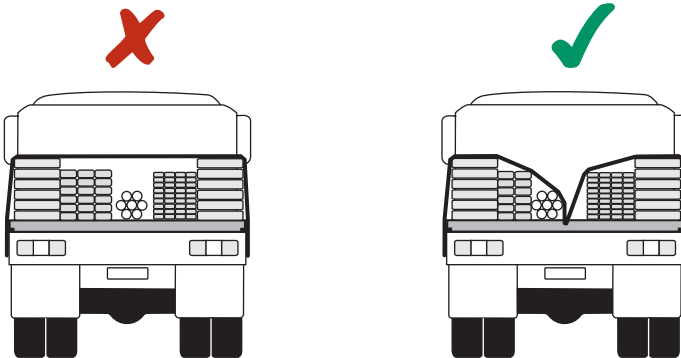


Fig. E.15

DIVIDED CROWNED LOAD



Section E - Loads

4.6 Long Lengths

Long lengths should be carried on vehicles with suitable length bodies, that ensure that the load is adequately supported and meets allowable length and overhang Regulations.

4.6.1 Flexible long lengths

Flexible long lengths include small diameter metal pipe, plastic pipe, timber, rod and rolled steel sections either loose or packaged. They should be supported regularly over their full length to minimise any whip effects. Any loose ends protruding from the load should be secured.

Where long lengths are transported on roof or ladder racks they should not overhang by more than 20% of their length and must be restrained with at least two lashings (see Table E.1).

LOAD SUPPORT POINTS		
Length	Distance between supports	maximum overhang
2500 mm	1500 mm	500 mm
3000 mm	1800 mm	600 mm
4000 mm	2400 mm	800 mm
5000 mm	3000 mm	1000 mm
6000 mm	3600 mm	1200 mm
7000 mm	4200 mm	1400 mm
8000 mm	4800 mm	1600 mm

Table E.1

4.6.2 Rigid long lengths

Rigid long lengths include large diameter metal pipe, heavy rolled steel sections, steel fabrications, large logs and concrete beams. They should be supported at only two points to allow the vehicle chassis to retain its flexibility.

Rigid long lengths should be supported at two positions each approximately 20% of the length from each end.

4.7 Short Pipes and Logs

Where loads are placed across the vehicle, they can be restrained by containment or tie-down.

Lashing(s) anchored at the front, passing over the top of a large number of sideways facing pipes or logs, and tensioned by a winch at the rear of the vehicle, cannot provide enough clamping force on all of the intermediate pipes or logs. The intermediate pipes or logs can then move out sideways and the entire stack could fall off. Additional lashings are needed so that the entire load is positively clamped.

If the load of sideways facing pipes or logs is divided into several sections, each section can be crowned. Tie-down lashings may then positively clamp all of the load (see Figure E.16).

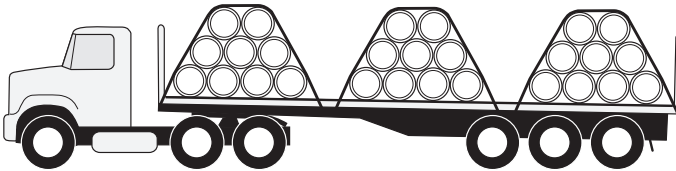
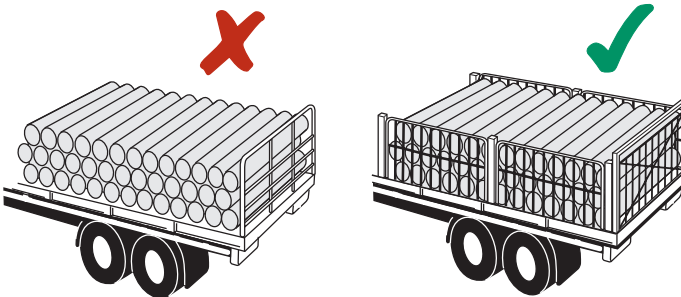


Fig. E.16

DIVIDED CROWNED LOAD

Where small pipes or logs are carried, suitable side gates or other containment methods, for example the use of chains, should be used to prevent sideways movement (see Figure E.17).



(Insufficient sideways restraint)

(Load restrained by gates)

Fig. E.17

SIDEWAYS RESTRAINT OF SHORT PIPES OR LOGS



Section E - Loads

Where large pipes are carried, all upper layer pipes should be individually tied down so that all pipes in the lower layers of the load are positively clamped by the upper pipes to prevent sideways movement (see Figure E.18).

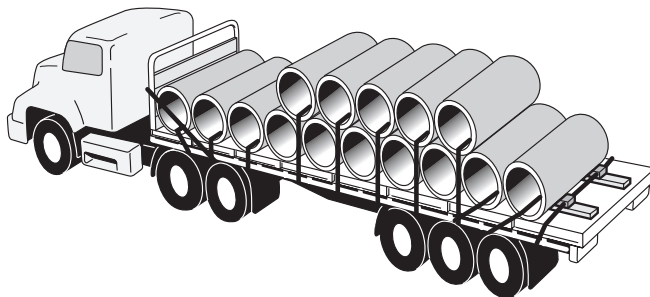


Fig. E.18

LARGE DIAMETER PIPES



5 SHEETS AND FLAT LOADS

The following contains information on restraining sheet, plate, stacked empty pallets and similar flat items.

5.1 Sheet and Flat Plate

Large loose sheets and flat plate should be restrained in all directions by blocking against suitable headboards, bulkheads, coaming rails, stanchions, pegs, stakes etc. Tie-down lashings should generally not be relied on to provide the total restraint in the forward direction, but can be used to provide additional restraint.

Metal sheet and flat plate laid flat on a vehicle is usually a load with a relatively low height. Lashings passing over coaming rails and over the load will often not be angled enough to effectively clamp the load to the vehicle. Tie-down is not an efficient form of restraint in this case because the lashing angle effect is low. The load should be lifted or additional items placed on top, so that the lashings are angled at least 30 degrees to the horizontal. The lashing angle for sheets that are wider than the vehicle can be increased by lifting the load.

Stacked sheets of plywood or building boards can easily slip on each other because of loose particles (for example sawdust, powder) which act like 'ball bearings' between the layers. They should be prevented from sliding by unitising into packs or fully containing them within sides or gates of a body. Alternatively, if tie-down is used, they should be blocked against sides, gates or stakes.

Loose sheets must be secured in open vehicles if they can be dislodged by air flow.

5.2 Empty Pallets

Empty pallets should be stacked no more than 15 pallets high to maintain sideways stability. The front of the load should be stacked against a headboard or a braced loading rack (see Section C).

Each row of pallets should be restrained by a fully tensioned webbing strap (at least 300 kg pre-tension). Ropes are not suitable for full loads.

A rope with a single hitch is not capable of restraining a single timber pallet located in the centre of the deck unless it is against a headboard. The angle of the rope is so low that the clamping force is almost nothing.

When the pallets are blocked against the headboard, a rope with a single hitch will only restrain eight pallets in one row, four high on a steel deck.



Section E - Loads

6 BALES, BAGS AND SACKS

The following contains information on restraining loads that are compressed into bales or contained in bags or sacks.

Baled loads include wool, cotton, wood pulp and hay.

These loads are usually low or medium density and stacked high. High loads reduce vehicle stability, which can cause loss of vehicle control and overturning in corners.

Bales, bags and sacks are manufactured from natural and synthetic materials, some of which have slippery surfaces. This can make them difficult to restrain by tie-down.

Bales, bags and sacks can settle quickly during transport. Lashings should be checked and re-tensioned regularly during the journey. It can be necessary to recheck the lashing tension within the first few kilometres of the journey for some products such as sacks of grain and bales.

The load must be placed so that its overall width and height does not exceed maximum allowable dimensions during the journey taking into account any settling of the load.

6.1 Bales

Bales can be carried on open vehicles by a combination of tie-down and containment by front and rear loading racks. Tie-down lashings are used to restrain the load sideways and the racks supply the rearward and additional forward restraint required. Specially designed cap tarpaulins can assist in restraining the top layers of bales only and should be rated by their manufacturer for this purpose.

Bales stacked three or four high tend to bulge outwards at the base or to lean outwards at the top. This occurs because of their lack of rigidity, stacking on end and the low friction of the bale material.

It is often, therefore, necessary to tie-down the bottom half of the load separately from the top. For additional sideways support, the load can be split in places along its length and diagonal lashings applied through the gap to the opposite side.

Where possible, bales should be stacked in interlocking patterns (similar to a brick bond) to provide better stability and spread the clamping forces from the tie-down lashings through to the lower bales.

Where cap tarpaulins are used, tie-down lashings must be placed over:

- at least every second bale on the top row.

Where cap tarpaulins are not used, tie-down lashings must be placed over:

- every exposed bale on the top row, or
- at least every second bale on the top row, after a horizontal belly lashing has been applied around that row.

Additional forward and rearward restraint should be provided by front and rear loading racks. The racks should be braced near the top on each side by a chain. A single 9 metre long chain wrapped around each of the rack side uprights and strung across the face of the rack is recommended (see Figure E.19).

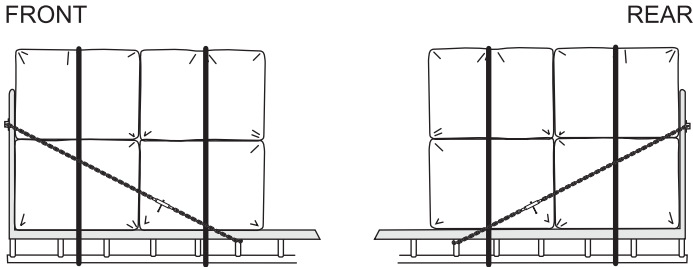


Fig. E.19

CHAINED LOADING RACK

Bales can also be contained by side gates and front and rear loading racks. Diagonal or cross lashings or braces should be used to prevent the side gates spreading outwards at the top.

6.2 Bags and Sacks

Bags or sacks should be laid on their sides when possible, and packed with alternate layers at right angles. No more than two successive layers should be packed in the same direction and the load should be of uniform shape.

If side gates or drop sides are not fitted, tie-down lashings must be used to restrain the load sideways. Tarpaulins can be used to assist in restraining the top layers of bags/sacks only.

Where tarpaulins are used over the load, tie-down lashings must be placed over at least every second bag on the top row.

Where tarpaulins are not used, tie-down lashings must be placed over every exposed bag/sack on the top row.



Section E - Loads

7 CONTAINED LOADS

Contained loads should be packed tightly together within the vehicle's body or sides to prevent any horizontal movement. Where loads cannot be packed tightly together, they must be restrained if their movement could cause the vehicle to become unstable or the load to dislodge.

Load separators, such as empty pallets, tyres, shoring bars or dunnage should be used where necessary to restrain individual items within the load and to protect fragile items from damage. Smaller items may be restrained by surrounding them with larger items.

Where a load is carried in an open body without any vertical tie-down, the base of each item of load should be well below the top of the sides or gates. This should prevent the load from becoming dislodged over bumps and vibration caused by rough road surfaces, especially on corners. Standard coaming rails are not high enough to ensure loads do not dislodge under these conditions. Higher sides or gates are required for vehicles with stiff suspensions that give a rough ride.

Loads which might 'bounce' as a result of road bumps should always be tied down. These items include vehicles and equipment on pneumatic tyres and/or springs and objects that bounce when dropped on a rigid surface.

Tarpaulins and nets can be used to provide vertical restraint for light loads contained in open sided bodies to counteract the effect of air flow and rough roads.

Side curtains can be used to contain loads provided that the vehicle and curtain system are certified for the particular application.

Incorrect loading in a freight container can adversely affect the carrying vehicle's weight distribution or stability, especially if the load shifts during transport. The load should be arranged where possible so that its weight is evenly distributed over the floor and packed tightly against the walls of the container. Drivers should ask the consignor for information on the packing of the container.

Any general freight container with uneven weight distribution (more than 60% of the load in less than half its length) should be clearly marked by the consignor with a centre of mass cargo symbol, to enable any necessary special precautions to be made for its transport.

Lightweight objects should be placed on top of heavier objects to keep the centre of mass of the vehicle as low as possible. The load should not exceed the manufacturer's rated capacity of the container or carrying vehicle, or cause the vehicle to exceed the legal axle loads unless operating under a special permit.

Freight containers should be packed to ensure that loads and dunnage will not fall out when the doors are opened. Lashings or webbing nets or, alternatively timber or metal gates, can be used for this purpose.

An internal restraint system (see Figure E.20) is required for partially loaded containers and heavy individual objects. Any movement of the load inside the container during transport could adversely affect the carrying vehicle's stability or weight distribution. A tightly packed load generally requires no additional restraint. Inflatable air bags (disposable or reusable) can be effectively used to restrain loads within containers.

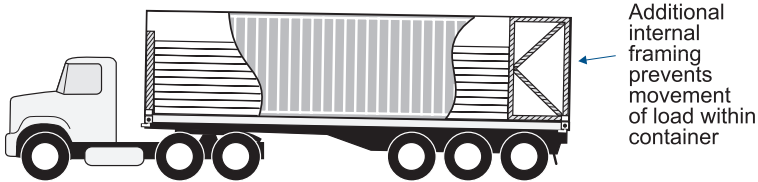


Fig. E.20 **ADDITIONAL RESTRAINT INSIDE CONTAINER**

7.1 Loose Bulk Loads

Loose bulk loads include quarry products, primary produce and demolition and waste material. These can be carried in tippers, drop-sided vehicles and tankers.

Fine powdered material should be contained or transported in fully enclosed vehicle bodies such as tankers so that no product can fall or dislodge from the vehicle during transport.

Tarpaulins, load covers or load nets are required to restrain loose particles and objects in open topped vehicles to counteract the effect of air flow and rough roads (see Figure E.21 and Figure E.22).

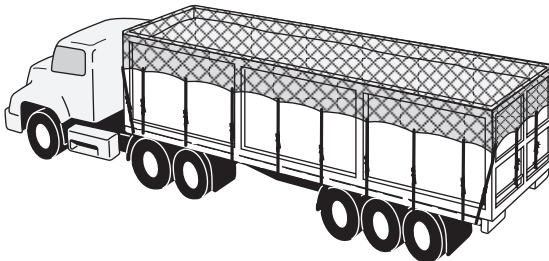


Fig. E.21

TARPAULIN



Section E - Loads

The use of 'wetting' or 'skinning' agents can be effective for a limited time in restraining fine particles without the need for tarpaulins.

Load covers can be made from closed or open-weave material and can be applied manually or mechanically.

Load nets can also be used effectively for vertical restraint of lightweight bulk loads in open-topped vehicles.

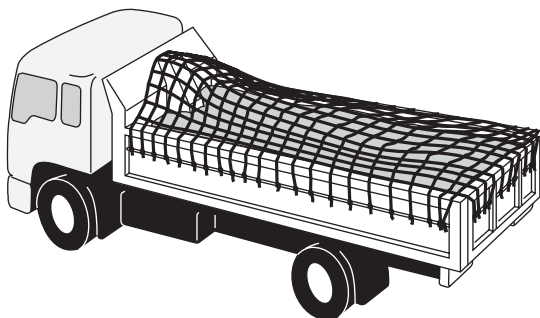


Fig. E.22

LOAD NET

Where tipper bodies contain loads that have any liquid content (including waste, foodstuffs, hides, offal, sand and gravel) which could leak onto a road, the liquid must be removed or drained before transport. Alternatively, the tipper must have a fully sealed body.

The vehicle body should be suitable for the type of material being transported. Bodies with poorly fitting and distorted sides and gates should not be used to transport fine particles such as sand.

Loose loads should never be transported on a platform-bodied vehicle without sides or gates or tipper bodies without tailgates (see Figure E.23 and Figure E.24).

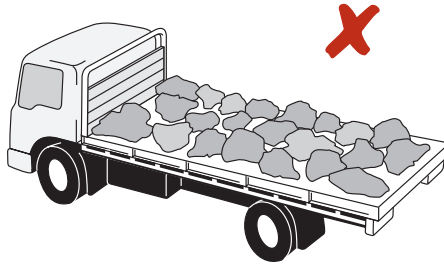


Fig. E.23

INCORRECT: UNRESTRAINED LOAD

Fig. E.24

CORRECT: LOAD CONTAINED

Some loads such as empty aluminium drink cans, are not suitable to be carried in long open top vehicles. This is because their shape, surface finish, size and/or weight may allow them to interact and move during braking or cornering. Any load which could jump out over bumps or be blown off by air flow must be covered and/or partitioned if it can move within the body.

Scrap metal consists of a variety of shapes and sizes. It is carried in bins, skips containers and sided vehicle bodies.

Where open bodies or containers have ramped ends for unloading, the ramp should always face rearwards to reduce the risk of the load 'launching' up over the end under braking.

Care should be taken to ensure that no large heavy objects are left unrestrained in a partial load of scrap and lightweight objects cannot bounce off over bumps.



Section E - Loads

7.2 Loose Individual Loads

Loose individual loads include cartons, boxes, crates, plastic containers, tools, tyres equipment, building supplies, individual glass bottles and bricks.

These loads should be arranged to prevent horizontal movement. Where possible, they should be interlocked and stacked to a uniform height, with the heavier items placed at the bottom of the load.

Where open containers, skips, crates or pallets are restrained on a vehicle, their contents must also be effectively contained. For example, bottles and containers in open crates, and bricks on brick pallets, can easily become dislodged during normal driving. They should be covered or otherwise contained on the vehicle.

7.3 'Live' Loads

'Live' loads are those loads that can be expected to move when transported such as livestock, hanging meat and all liquids. Liquids include high viscosity sludges, molasses and tar.

Live loads can reduce vehicle cornering ability and cause roll-over.

If liquids are transported in partially filled tanks they should be baffled or have multiple compartments which are either essentially full or empty.

Livestock is normally carried in purpose-built bodies or removable crates.

Livestock should be loaded to minimise injury to individual animals and to prevent vehicle instability by the livestock moving during transport.

Where livestock is carried on light vehicles, crates must be used or the livestock directly restrained (tethered) to minimise movement.

Where livestock is carried in multiple deck crates, animals should not be transported in an upper deck until the lower levels are filled.

Where loads such as meat, are hung in a vehicle, they must be closely packed to minimise movement or otherwise be restrained.

8 LARGE LOADS

The following contains information on restraining large individual items of load including containers, tanks, portable buildings, castings, large fabrications, transformers and tall loads.

The effect of the height of the centre of mass of the load on vehicle stability should be taken into account when selecting the carrying vehicle. Drop deck trailers or low-loaders should be used for high loads.

8.1 Containers

Containers include shipping containers, flat platforms (Transiflats), bins, skips and tanks.

8.1.1 Shipping containers

All ISO and most other shipping containers and flat platforms are equipped with corner castings designed to interlock with mating 'twist locks' (see Figure E.25), either for lifting or restraining them for transport.

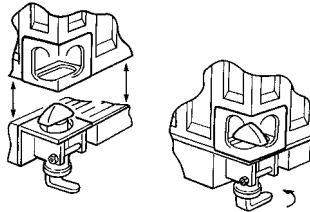


Fig. E.25

TWIST LOCK

All shipping containers should be restrained by four twist locks although tie-down methods can be used in some cases.

Tie rails and lashing equipment on general freight vehicles are not strong enough to directly restrain fully laden freight containers.

Where twist locks are not fitted, empty containers can be restrained by either crossed-chains (see Figure E.26) or tie-down (see Figure E.27). They must be placed either on a timber deck, on timber dunnage, on rubber pads, or friction matting, but not directly onto a metal loading deck or coaming rails.

A load mat or rubber pad capable of withstanding the high pressure under the corner casting of an empty container without breaking up must be used.

For restraining empty containers up to 2.7 tonnes, transport chains should be at least 8 mm diameter and tensioned with turnbuckles or dogs to at least 1000 kg.



Section E - Loads

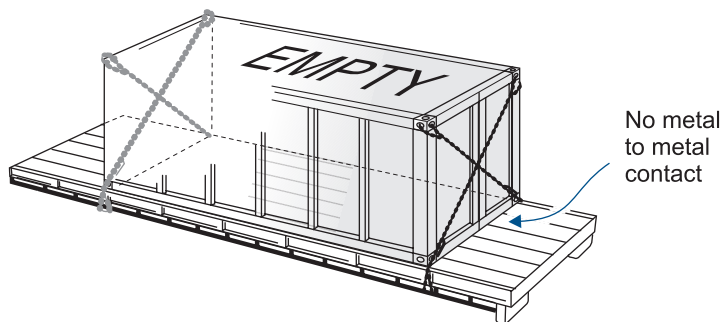


Fig. E.26 **EMPTY CONTAINER – CROSS CHAINED**

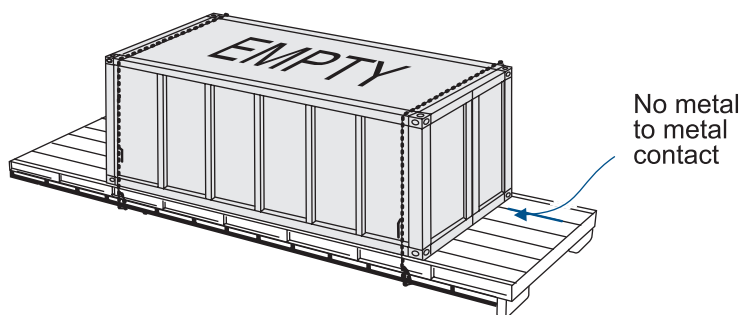


Fig. E.27 **EMPTY CONTAINER – CHAINED OVER TOP & 'DOGGED' BOTH SIDES**

Tank containers should be transported on low trailers (see Figure G.3, page 216). The bottom corner castings on an ISO tank container should be no higher than 1100 mm above the ground, to ensure maximum stability.

A load restraint system can be developed, tested and certified to restrain laden containers using chains, by tie-down or a combination of tie-down and direct restraint.

As an example, a certified tie-down system for a 22.5 tonne container would utilise four 8 mm transport chains, tensioned to a minimum of 2000 kg with rated turnbuckles, using a proven procedure. At least four lengths of timber dunnage would be placed under each end of the container, but not under the corner castings. Friction matting would be placed between the dunnage and container and also between the dunnage and the deck. The friction matting would require a minimum friction coefficient of 0.6 and have sufficient strength to prevent it breaking up or extruding under the heavy weight. Conveyor belting would not be suitable for this application. The container could not directly contact any timber, metal deck or coaming rail (see Figure E.28).

Other chain lashing systems could be developed, tested and certified using a combination of four tie-down lashings and additional direct restraint lashings preventing forward movement, to enable even heavier containers to be restrained.

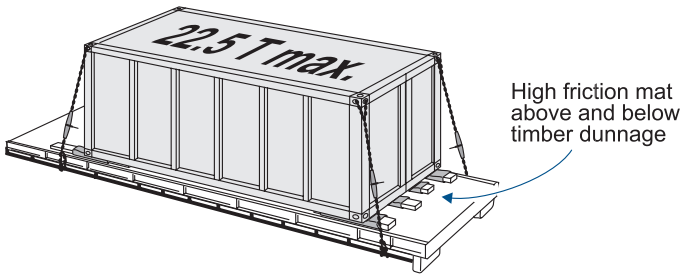


Fig. E.28 **22.5 TONNE CONTAINER – TURNBUCKLE CHAINED**

Flat platforms and low height containers can be stacked and secured with interlocking double twist lock fittings (see Figure E.29).

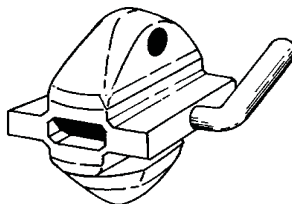


Fig. E.29

DOUBLE TWIST LOCK



Section E - Loads

8.1.2 Tanks, bins and skips

Tanks, bins and skips should be restrained on the vehicle by lashings or positive locking devices. To achieve this they should be fitted with lashing anchor points or mounting frames.

Skips and bins must be restrained to the vehicle whether they are full or not. Hydraulic arms are not suitable as a restraint system.

A small tank can be mounted on a frame fitted with four twist lock castings (see Figure E.30).

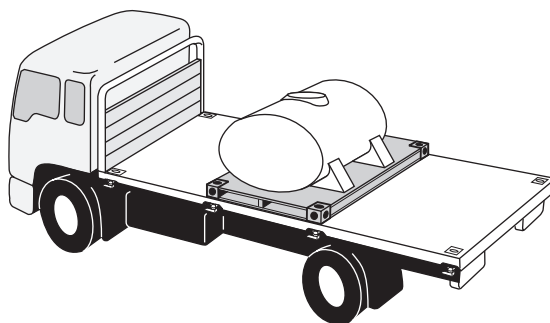


Fig. E.30 **SMALL TANK RESTRAINED WITH TWIST LOCKS**



8.1.3 Bladders and flexible tanks

Bladders and flexible tanks are specialised containers, which can be used to transport some liquid products. They are usually made of fabric-reinforced rubber and when empty can be rolled up to reduce their size for transport.

The method of restraint should take into account the flexibility and surge effects during transport.

These tank types can be restrained by lashing onto the vehicle deck or lashing inside a freight container.

Where it is not possible to adequately restrain a flexible tank inside a freight container, the container should be transported on a 'drop-deck' trailer to minimise the surge effects on the semi-trailer's stability.

MINIMUM NUMBER OF LASHINGS			
Mass of tank plus contents	Minimum no. of lashings	Mass of tank plus contents	Minimum no. of lashings
0—1.99 t	3	10.00—11.99 t	8
2.00—3.99 t	4	12.00—13.99 t	9
4.00—5.99 t	5	14.00—15.99 t	10
6.00—7.99 t	6	16.00—17.99 t	11
8.00—9.99 t	7	18.00—19.99 t	12

Table E.2

If chains are used, a protective covering should be placed between the chain and the tank to minimise abrasion damage.

The lashings on flexible tanks may be arranged as individual straps or as a webbing net.



Section E - Loads

Individual straps should be run from the anchor point on one side of the vehicle, over and belly wrapped in a full circle around the tank, down to the vehicle anchor point on the opposite side (see Figure E.31).

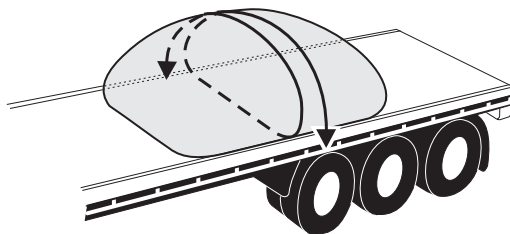


Fig. E.31

ARRANGEMENT OF LASHINGS

Lashings should be spaced closer together at the front portion of the tank to counteract liquid surge effects during braking (see Figure E.32).



Fig. E.32

LIQUID SURGE DURING BRAKING

Webbing nets should be attached at regular intervals to vehicle anchor points. Where there are no fixed anchor points across the vehicle, the net should be attached at the front and rear of the tank, to strong cross beams or chains, secured at each end to the vehicle (see Figure E.33).

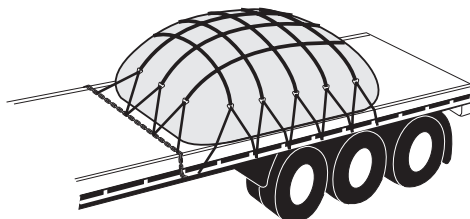


Fig. E.33

WEBBING NET

8.2 Portable Buildings

The upper structures of most portable buildings and site sheds are not suitable for attaching lashings. However, base frames or steel skids can be used.

Tie-down lashings are not suitable if placed over the skids. The lashing angle is too low to provide sufficient clamping. It is limited by the height of the skids or base frame.

The building should be loaded so that it can be blocked against the headboard.

Where the building cannot be blocked against the headboard, lashings should be attached at the rear, to prevent forward movement.

To prevent sideways and rearwards movement, lashings should be attached directly at the front and back.

Separate lashings should be attached to each side and each end of the building (see Figure E.34). All lashing assemblies should have a minimum lashing capacity of 3 tonnes. Stronger lashings may be required depending on the weight of the building and contents and the angles of the lashings.

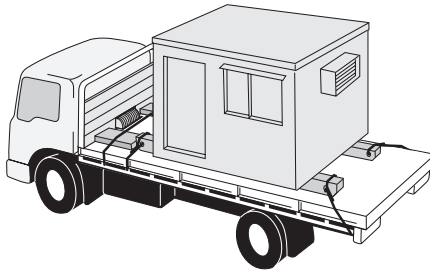


Fig. E.34 **RESTRAINING A PORTABLE BUILDING**

Recovery winches should not be used for restraining loads, unless they are fitted with a positive locking mechanism.

8.3 Large Castings and Fabrications

Large castings are normally transported on custom-made cradles. The cradles spread the weight of the casting over the deck. The casting may be restrained by tie-down and/or direct lashings.

Where possible they should be blocked at the front to prevent forward movement.

Large fabrications should be placed on rubber load mat or timber dunnage. They can be restrained by tie-down and/or direct restraint, by attaching lashings and/or blocking at the front and sides.

Section E - Loads

9 VEHICLES AND MOBILE EQUIPMENT

The following contains information on restraining vehicles and mobile equipment.

Vehicles and mobile equipment include rubber tyred, steel wheeled and tracked vehicles. They can vary considerably in size and weight.

9.1 Selection of Carrying Vehicle

Small vehicles and mobile equipment may be carried on general freight vehicles.

Large items of mobile equipment should be carried on special-purpose vehicles with low decks. This will keep the centre of mass as low as possible to ensure maximum vehicle stability.

9.2 Load Requirements

Vehicle and mobile equipment manufacturers should provide loading and restraint recommendations and should fit appropriate lashing points.

Note that some manufacturers' existing load restraint recommendations may include tie-down information suitable for sea transport or rail transport but not for road transport. The principles outlined in this guide should be followed for road transport.

9.2.1 Lashing points

Chains can be attached by looping around parts of the load. However, this can damage fragile components such as brake pipes, or weaken the chains on sharp edges.

Lashing points should be fitted in positions to enable adequate and efficient restraint (see Figure E.35).

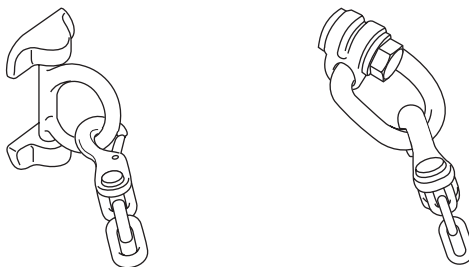


Fig. E.35

LASHING POINTS



Lashing points should be clearly identified by colour coding or labelling.

Front and rear towing brackets can be used as lashing points. Where the brackets do not incorporate round pins, shackles should be used to prevent weakening or damaging the chain.

Many lifting lugs are incorrectly positioned for load restraint (even if identified as tie-down points) and should not be used.

9.2.2 Articulated vehicles

When transporting articulated machines, steering locks should be engaged.

Steering controls should be operated at least twice with the engine stopped to relieve residual hydraulic pressure.

9.2.3 Movable parts and attachments

Any part of the equipment (eg. excavator booms) which can rotate must be restrained for transport.

Buckets, blades and rippers should be lowered onto the deck. When travelling on rough roads, these items should be restrained to prevent damage.

9.2.4 Controls

The manufacturers' recommendations regarding the positioning of transmission controls and the application of parking brakes should be followed.

Loose objects that could move and contact controls should be removed or restrained for transport.

9.2.5 Height

High loads must not exceed regulation height limits and must be lower than any obstruction (eg. bridge, overhead wire) which could be encountered during transport.

9.2.6 Tyres

The tyres on rubber tyred vehicles or equipment should be checked for correct pressures and the presence of leaks.

9.2.7 Wide loads

Where the mobile equipment is wider than the vehicle deck, a widening low loader, outriggers or extensions should be used for maximum support. At least 75% of the normal contact area of equipment tyres or tracks should be supported. Any unsupported tyre or track should not project more than 150 mm beyond the vehicle deck or extension.



Section E - Loads

9.3 Tie-down and Direct Restraint

The restraint of vehicles and mobile equipment should be by direct lashings and/or blocking wherever possible.

9.3.1 Tie-down

Rubber tyred and rubber tracked vehicles can be restrained using tie-down in the sideways direction, but not in the forward or rearward directions.

The friction between wheels and tracks on loading decks can be extremely low, especially when wet or greasy. In such cases, friction should be neglected and tie-down should not be used.

9.3.2 Direct restraint

Tracked and wheeled vehicles should be directly restrained in the forward and rearward directions by lashings. In the case of extremely heavy equipment, the combination of direct restraint and tie-down can be used. Vehicles and mobile equipment can also be restrained by containing them within the body structure of the carrying vehicle.

9.3.3 Combined tie-down and direct restraint

Where tracked equipment is restrained forward or rearward on timber decking or rubber matting, combined tie-down and direct restraint can be used. In such cases, direct lashings must be attached to the tracks, not to the undercarriage or body. This is to allow the load to move and take up any free play in the transmission.

The restraint must not rely on transmission and wheel parking brakes, engine braking or hydraulic winches, except where positive locks (pawls) are fitted.

9.4 Lashings

Vehicles and mobile equipment can be restrained using webbing, chain or wire rope lashings.

Webbing lashings are suitable for light motor vehicles and equipment. Webbing assemblies can be single or endless lashing assemblies (see Figure E.36) or wheel restraints (see Figure E.37) which are tensioned with hand ratchets.

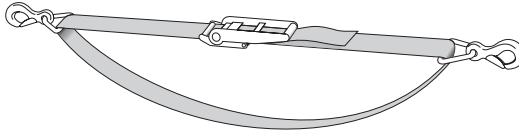


Fig. E.36

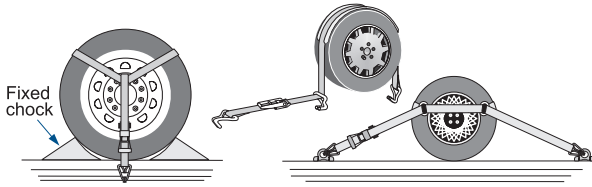
WEBBING ASSEMBLY

Fig. E.37

WHEEL RESTRAINT ASSEMBLY

Chain is suitable for restraining all vehicles and mobile equipment that are fitted with suitable attachment points.

Chain can be loose lengths fitted with grab or claw hooks at each end, or take the form of an assembly with latch hooks, a built-in tensioner and a shortening claw (see Figure E.38). Chain assemblies are one-piece, eliminating the chance of the tensioner dislodging from the vehicle.

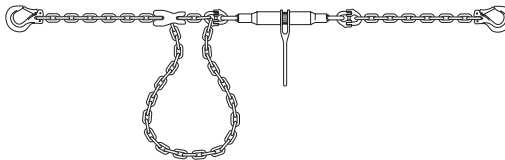


Fig. E.38

CHAIN ASSEMBLY

When restraining rubber tyred equipment, dogs and turnbuckles should be tied or wired in position to prevent them becoming detached if the chain slackens. Alternatively, chain assemblies should be used.



Section E - Loads

Chains restraining mobile equipment are often short, making them difficult to fully tension using dogs. Turnbuckles are more suitable for tensioning short chains.

Wire rope can be used for restraining vehicles and mobile equipment. The lashing capacity of wire rope is one third of its minimum breaking strength (see Section H). Winches used to tension wire rope should have a positive locking feature and not rely on hydraulic pressure to prevent the winch unwinding.

9.5 Attaching lashings

Two lashings attached to the towing pin (see Figure E.39) will provide positive sideways restraint.

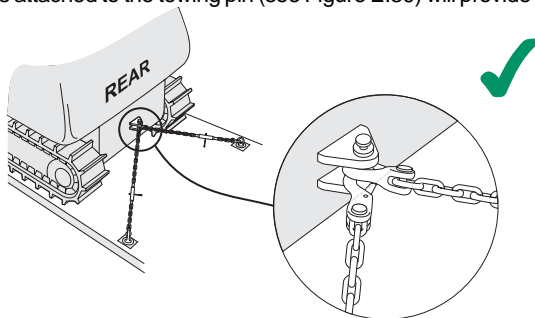


Fig. E.39 **LASHINGS ATTACHED TO TOWING BRACKET**

One lashing passing around the towing pin (see Figure E.40) will not prevent sideways movement. This arrangement should only be used for restraining small rubber tyred equipment where the rubber tyres can give the required sideways restraint, provided the tyres always stay in contact with the deck.

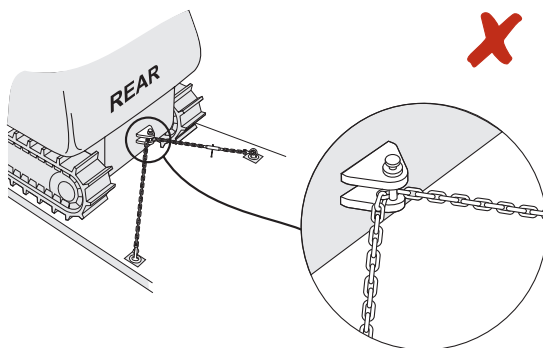


Fig. E.40 **LASHING PASSING THROUGH TOWING BRACKET**

Lashings can be easily attached when the equipment is fitted with special lashing points (see Figure E.41). Fitting such lashing points can save loading time if the equipment is frequently transported. These fittings are available through chain suppliers.

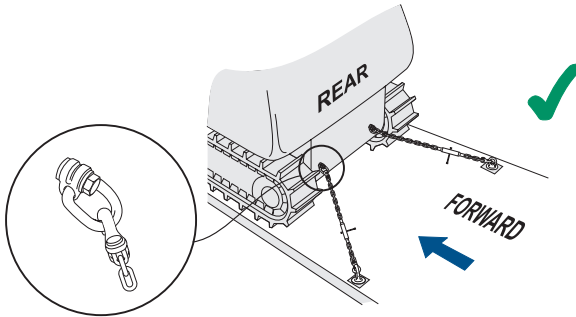


Fig. E.41 USING LASHING POINTS

When the chains pass over the sharp edges on coaming rails or on the mobile equipment, they can be weakened significantly. (see Section C 6.5 for derating chain). Suitable rounded corner protectors should be used. Alternatively, the chains should be positioned to give a straight line pull.

9.6 Restraining Tracked Equipment

The following refers to the restraint of equipment on metal tracks. The principles also apply to equipment with metal wheels and rollers. More detailed information is in Section E 9.8.

Where four angled chains are used to restrain a tracked machine:

- the two chains at the rear preventing forward movement should be angled at approximately 30 degrees to the forward direction (see Figure E.42) and;
- the two chains at the front preventing rearward movement should be angled at approximately 45 degrees to the forward direction.

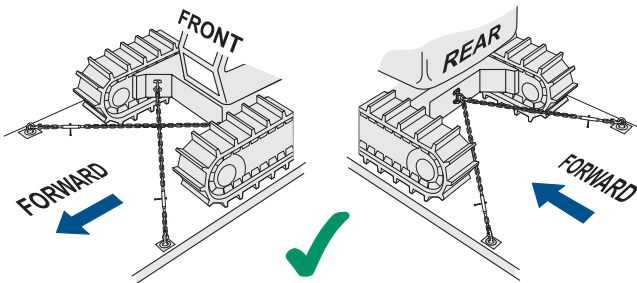


Fig. E.42 RESTRAINED BY FOUR CHAINS



Section E - Loads

When the front of a tracked machine is blocked to prevent forward movement (eg. the bucket is against a gooseneck or the blade is against a stop bracket on top of the gooseneck):

- Two chains must be attached at the rear to prevent sideways movement. They can be angled straight across the deck and crossed for ease of attachment (see Figure E.43).
- Two chains must be attached at the front to prevent sideways movement.
- Two chains must be attached to prevent rearward movement. These chains can be the same two front chains if they are angled back correctly (see Figure E.43). Alternatively, they could be additional chains attached at other suitable positions at the front or sides.

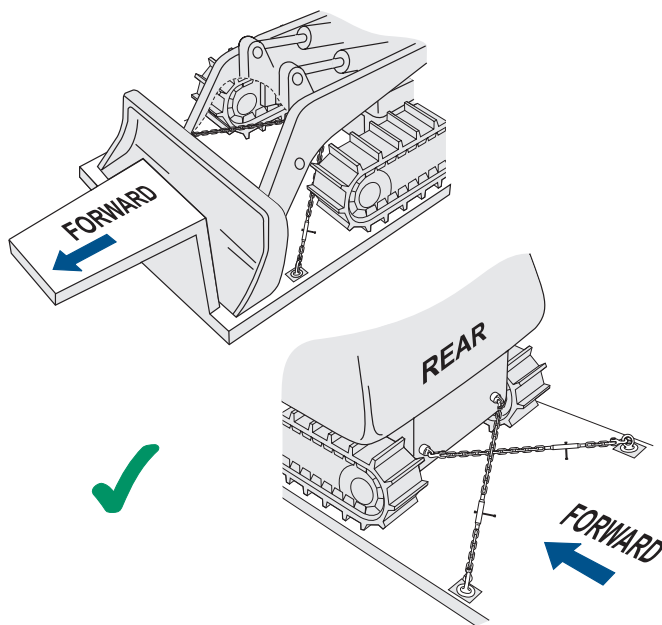


Fig. E.43 **BLOCKED AT FRONT AND CROSS-CHAINED AT REAR**

Tie-down is the wrong method of restraint for tracked machines because there is not enough friction to fully restrain the machine.

Tracked machines must not be restrained by tie-down chains over the tracks (see Figure E.44 and Figure E.45).

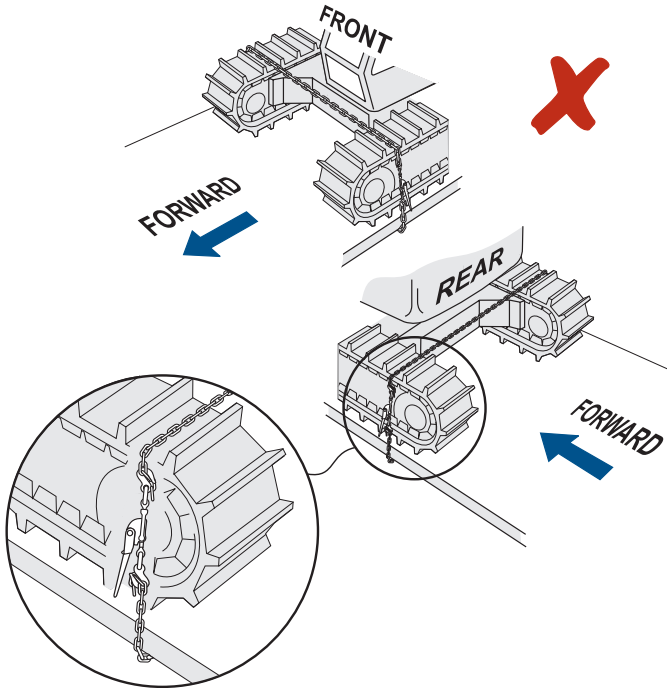


Fig. E.44

TWO CHAIN TIE-DOWN - INADEQUATE RESTRAINT



Section E - Loads

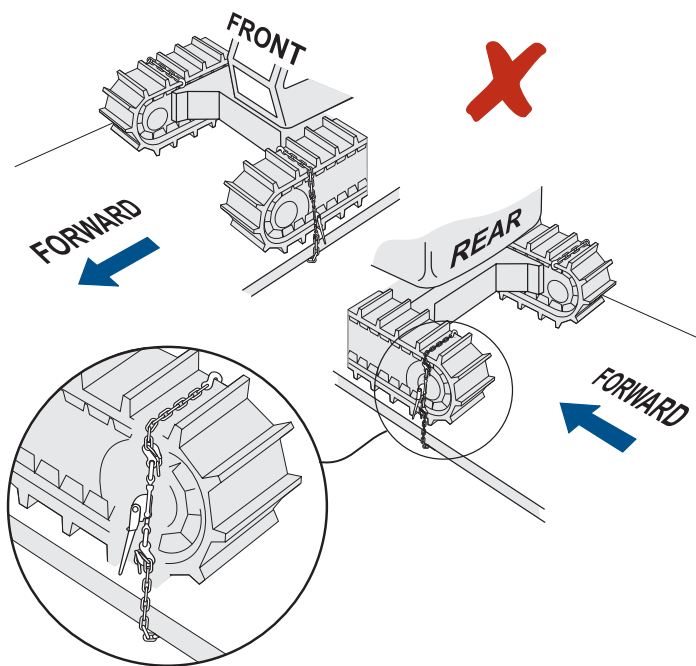


Fig. E.45 **FOUR CHAIN TIE-DOWN ON TRACKS - INADEQUATE RESTRAINT**

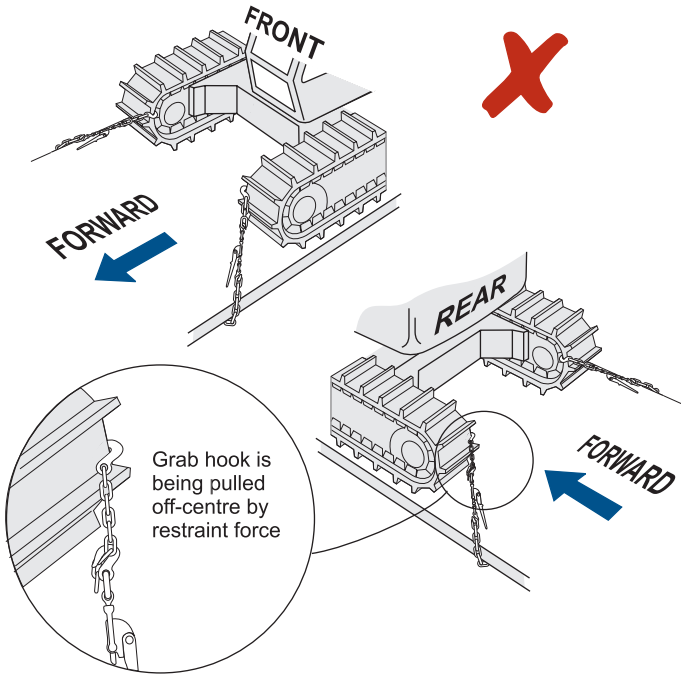


Fig. E.46 **FOUR CHAINS DIRECT RESTRAINT ON TRACKS - INADEQUATE RESTRAINT**

Tracked machines must not be restrained by angled chains attached to the tracks with grab hooks (see Figure E.46).

This method is not adequate for forward and rearward restraint. Attaching chain grab hooks to track shoes is not recommended. Grab hooks are not normally designed for tip loading or rated for this purpose.

Worn track shoes and track chain on used or old equipment may not be attached strongly enough to withstand the load restraint forces.



Section E - Loads

9.7 Restraining Rubber Tyred Vehicles and Equipment

The friction from rubber tyres can provide some of the load restraint.

However, because brakes cannot be relied on to prevent the wheels rotating, the friction of the rubber tyres on the deck can only be used to prevent sideways movement.

Where lashings prevent a wheel from rotating, the restraint provided is in all horizontal directions.

Lashings must be pre-tensioned to keep the tyres in contact with the deck. The resulting clamping force must be at least 20% of the weight of the load.

Where large balloon tyres are fitted, excessive sway of the load may occur if the sideways restraint is only the friction of the rubber tyres on the deck. In such cases, the load should be directly restrained sideways.

9.7.1 Rubber tyre bouncing

High shock forces can develop in chains, when vehicles or mobile equipment that are being carried 'bounce' on their tyres or suspension during transport. This can occur during braking, accelerating, travelling on hills and rough roads.

During braking, the tension increases in the chains that prevent forward movement.

Because the chains are angled upwards from the deck, they pull down on the load when the tension increases. This pull down force compresses tyres and suspensions and the load rocks forward.

When the braking, or accelerating, is finished, the increased chain tension reduces to its original value. The tyres and suspension then rebound upward to their original position causing the vehicle or mobile equipment to 'bounce' or rock backwards (see Figure E.47).

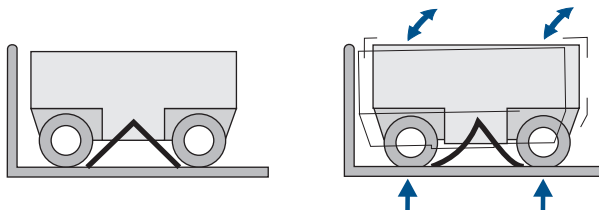


Fig. E.47

RUBBER TYRE BOUNCING



The bouncing effect is magnified when the chains are angled steeply to the deck. This is because steeply angled chains pull down on the load more than chains at a lower angle.

Direct lashings should be angled at no more than 25 degrees to the horizontal (1:2) to minimise bouncing.

Bouncing can also be reduced by adding vertical lashings at each wheel position. These lashings should have a lashing capacity of at least half the weight of the equipment and should be as tight as possible.

Bouncing can also be prevented by supporting the equipment on blocks or removing wheels for transport.



Section E - Loads

9.7.2 Small equipment

Small rubber tyred equipment can be restrained by two lashings. One lashing should be attached at the middle of one end of the equipment and the other lashing at the other end. The lashing can be attached to the deck at one point or it can pass through a towing bracket and attach to the deck at two points (see Figure E.48). The rubber tyres provide the sideways restraint and the lashings provide the forward and rearward restraint.

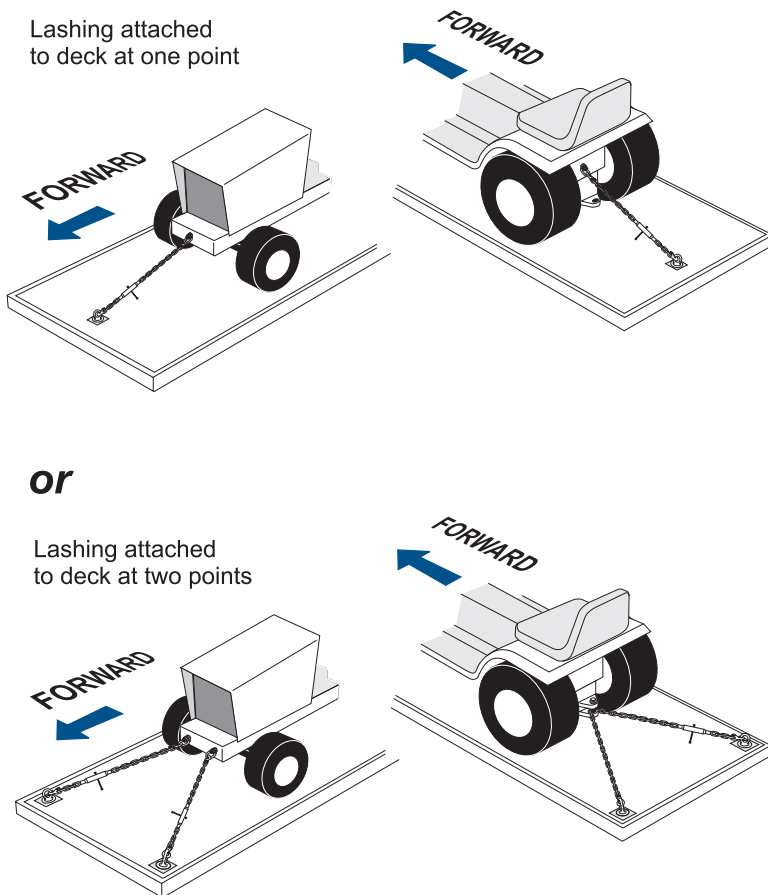


Fig E.48

SMALL RUBBER TYRED EQUIPMENT



9.7.3 Motor vehicles

Motor vehicles can be transported on specialised carrying vehicles or general freight vehicles.

Before restraining the vehicle, the overall height of the load should be checked, particularly when transporting light commercial and four-wheel-drive vehicles.

Most modern light vehicles are equipped with special underbody brackets to enable lashings to be attached. Some brackets are designed for vertical lashings and are positioned such that they are only suitable for use with purpose-built car carriers.

Where specially designed car carriers are used, purpose-built lashing assemblies and winches should be used to restrain the load. Vehicles should not be carried unrestrained on car carriers even though they might be contained by the structure joining the upper and lower decks on a double-deck carrier.

Where lashings are attached to axles or wheels, care should be taken to ensure the lashings do not damage brake pipes, hoses, anti-lock brake sensors or other components.

There are three basic methods of restraining motor vehicles:

- 1 Wheel restraint
- 2 Tie-down
- 3 Direct lashing

9.7.3.1 Wheel restraint method

The vehicle can be restrained directly or by tie-down, by webbing assemblies, which attach to or over the wheels.

9.7.3.2 Tie-down method

Tie-down lashings are vertical chains or straps attached underneath the vehicle and tensioned using fixed winches. They are only effective if the wheels are prevented from rotating by chocks or recesses in the deck.

Tie-down should not be used if vehicle parking brakes or transmission locks are the only way of preventing the wheels rotating.

Wheel chocks that can become loose and loose equipment, including ramps and lashing assemblies, must be adequately restrained on the carrying vehicle.

Note: *Wheel restraint and tie-down depend on the tyres remaining inflated during transport. If the tyre loses air, all restraint is lost. Tyre pressures should be checked before and during the journey.*



Section E - Loads

9.7.3.3 Direct lashing method

Direct lashings are attached to axles, suspension or lashing points. They should be angled at 25 degrees to the horizontal to minimise bouncing and within 30 degrees of the centreline of the carrying vehicle.

A minimum of two lashings must be used and arranged so that, when tensioned, a downward force is applied to each wheel.

Recovery winches should not be used for restraining loads, unless they are fitted with a positive locking mechanism. They cannot be used for tie-down unless they are tensioned to pull down on one end of the vehicle at a minimum of 25 degrees (1:2) or to give an equivalent force of 20% of the weight on the axle at that end.

9.7.4 Large equipment

When restraining large rubber tyred equipment it is essential that the lashings are angled correctly to minimise bouncing. The positioning of tie-down lugs on some large equipment can be misleading in this regard. They are sometimes intended for lifting but not load restraint. Their position can sometimes result in high lashing angles, which lead to excessive bounce.

In many cases, new lashing points will need to be fitted to successfully restrain some large equipment.

9.7.5 Small Rubber-tyred equipment

Small rubber-tyred equipment such as mowers and skid-steer loaders can be restrained without vertical tie-down, by containing them in open vehicles such as trailers and tippers, provided that:

- the vehicle bodies have side and end structures of adequate strength;
- the side and end blocking structures are vertical;
- the tops of the side and end blocking structures are at least 300mm above the deck and are higher than the top of any equipment tyres; and
- the side and end blocking structures are positioned to restrict movement of the equipment to a maximum of 100 mm in any horizontal direction. The use of intermediate packing between the equipment and blocking structures is acceptable, provided that the packing is at least as high as the structures and is restrained in position.



9.8 Suggested Methods of Restraining Mobile Equipment, Trailers and Other Vehicles

The following are examples of methods of restraining some vehicles and mobile equipment. Variations of these methods are acceptable, provided the restraint meets the Performance Standards.

9.8.1 Tracked excavator

When restraining an excavator:

- (i) Forward movement can be prevented by attaching two diagonal lashings (at 30 degrees to the forward direction) between the undercarriage lashing point and the deck on each side, or by butting the tracks against the trailer gooseneck (where weight distribution allows).
- (ii) Rearward movement should be prevented by the use of two diagonal lashings (at 45 degrees to the rearward direction) between an undercarriage lashing point and the deck on each side.
- (iii) Sideways movement will be prevented by the diagonal lashings that prevent the forward and rearward movement.
- (iv) Rotation of the operator's cabin should be prevented by engaging the slew lock and by lashing the bucket or the end of the dipper.
- (v) Movement of the boom, dipper & bucket should be prevented by attaching lashings directly to the bucket or dipper.

9.8.2 Dozer or tracked loader

When restraining a dozer or tracked loader:

- (i) Forward movement should be prevented by butting the bucket or blade against the trailer gooseneck or stop brackets on top of the goose neck (where weight distribution allows) or by attaching two diagonal lashings (at 30 degrees to the forward direction) between the rear lashing point(s) and the deck on each side.
- (ii) Rearward movement should be prevented by the use of two diagonal lashings (at 45 degrees to the rearward direction) between the front lashing point and the deck on each side.
- (iii) Sideways movement will be prevented by the diagonal lashings that prevent the forward and rearward movement.
- (iv) Vertical movement of blade/bucket/rippers may be prevented by applying lashings over or directly to the blade, bucket or rippers.



Section E - Loads

9.8.3 Restraining a wheeled loader

When restraining a wheeled loader:

- (i) Forward movement can be prevented by butting the bucket against the trailer gooseneck or by diagonal lashings (at 30 degrees to the forward direction) onto a towing bracket or lashing point.
- (ii) Rearward movement should be prevented by the use of two diagonal lashings (at 45 degrees to the rearward direction) onto a towing bracket or lashing point.
- (iii) The lashings should be angled at no more than 25 degrees to the horizontal to minimise bouncing.
- (iv) Sideways movement will be prevented by the friction between the rubber tyres and the deck and the diagonal lashings that prevent forward and rearward movement.
- (vi) Articulation of the machine should be prevented by engaging the locking mechanism, and ensuring the controls have been operated with the engine off, to relieve all hydraulic pressure.
- (vii) Vertical movement of the bucket may be prevented by separate lashings.

(see Section C 3.3 for information on rubber tyre bouncing).

9.8.4 Restraining a grader

When restraining a grader:

- (i) Forward movement should be prevented by butting the machine against the trailer gooseneck or by diagonal lashings (at 30 degrees to the forward direction) onto an axle, towing bracket or lashing points.
- (ii) Rearward movement should be prevented by diagonal lashings (at 45 degrees to the rearward direction) onto an axle, towing bracket or lashing points.
- (iii) The lashings should be angled at no more than 25 degrees to the horizontal to minimise bouncing.
- (iv) Sideways movement will be prevented by the friction between the rubber tyres and the deck and the diagonal lashings that prevent forward and rearward movement.
- (v) Articulation of the machine should be prevented by engaging the locking mechanism, and ensuring the controls have been operated with the engine off, to relieve all hydraulic pressure.
- (vi) Movement of the blade may be prevented by lowering it onto timber dunnage and applying separate lashings.

(see Section C 3.3 for information on rubber tyre bouncing).



9.8.5 Restraining a roller

When restraining a roller or compactor:

- (i) Forward movement should be prevented by butting the machine frame against the trailer gooseneck, the drop-frame or headboard, or by diagonal lashings (at 30 degrees to the forward direction) onto a towing bracket or lashing points.
- (ii) Rearward movement should be prevented by the use of diagonal lashings (at 45 degrees to the rearward direction) onto a towing bracket or lashing points.
- (iii) Sideways movement will be prevented by the diagonal lashings that prevent the forward and rearward movement.
- (iv) Articulation of the machine should be prevented by engaging the locking mechanism and ensuring the controls have been operated with the engine off, to relieve all hydraulic pressure.
- (v) Where water ballast is used, it can be drained before transport to reduce weight and make the roller easier to restrain.

9.8.6 Restraining a forklift

When restraining a forklift:

- (i) The overall height should be checked so that it is below regulation limits. The mast should be removed if necessary.
- (ii) Forward movement should be prevented by butting the machine frame against the trailer gooseneck or a headboard, or by diagonal lashings (at 30 degrees to the forward direction) onto a towing bracket, lashing points or around the mast.
- (iii) Rearward movement should be prevented by the use of diagonal lashings (at 45 degrees to the rearward direction) onto a towing bracket, lashing points, or around the mast.
- (iv) Sideways movement will be prevented by the friction between the rubber tyres and the deck.
- (v) Movement of steering and lifting gear should be prevented by engaging the locking mechanisms. The forks should be lowered onto timber dunnage which must itself be restrained on the deck.



Section E - Loads

9.8.7 Restraining caravans and small trailers

Caravans and small trailers can be transported on general freight vehicles provided that they are adequately restrained and meet allowable length and overhang Regulations.

Caravans and trailers with rigid drawbars should be restrained at the end of the drawbar and each side at the wheels or axles (see Figure E.49). They should be loaded, where possible, facing rearwards, with the end of the drawbar slightly past the rear of the deck.

The end of the drawbar should have a brightly coloured flag or piece of material attached to the end to indicate its projection to other road users. Rear overhang limits may also apply. (Also see page 42).

If the drawbar is not positioned over the rear of the deck, it should be lifted onto dunnage or a specially fabricated trestle or cross-beam (not a 'jockey' wheel), so that the lashings are angled downwards sufficiently to be effective.

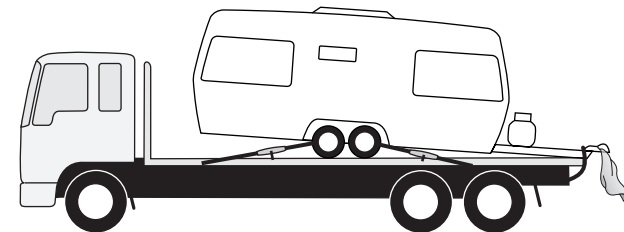


Fig. E.49

RESTRAINING A CARAVAN

The axle(s) or wheel(s) should be restrained by two separate lashings positioned diagonally in opposite directions on each side.

Trailers (including caravans) when transported over rough roads, can suffer from excessive bouncing if not fitted with shock absorbers. In such cases the suspension should be 'blocked' to prevent damage.

Where boat trailers carrying boats are transported, the methods outlined above should be used. The restraint of the boat on the trailer should be checked to see if it is adequate. The boat should have a strap over the stern, attaching it to the trailer. A safety chain should be used in addition to the wire rope from the trailer's boat winch to the bow of the boat. If the boat is fitted with an outboard motor, its mounting to the stern might not be designed to withstand the bumps and other road shocks encountered during road transport. It could be necessary to restrain the motor separately or remove it for transport.



A heavy load can fall off just as easily as a lightweight load. This is because the same 'g' forces apply, no matter what the weight.



This tracked excavator slid forward, the boom entering the drivers cabin. Because steel tracks slip easily on a steel deck, this machine should be restrained directly, using correctly sized and angled chains (see pages 156-161).



This bulldozer was not restrained and slid sideways off the low-loader. Steel on steel is low friction and therefore high risk.



These 26 drums are filled with ball bearings and weigh almost one tonne each. None are restrained. Note that the drums overhang the coaming rails making it even easier for them to fall off in a corner (see photo insert).



Some of these drums were unrestrained and others that were tied down with rope, did not meet the minimum restraint requirements (see page 66).



The loading rack and its support rope will not restrain these rail wheels and axles.



12 steel billets weighing 24 tonnes in all, pierced the cab of this truck. Note that the pipe loading rack (far right) was ineffective.



View from passenger's side.



Slippery bags caused this load to move. Such loads should be stabilised using rigid sides or braced side gates.



The tarpaulin did not restrain this load. Unless specifically designed and tested for the purpose, tarpaulins should not be used as the main load restraint system.



This load slipped, causing the truck to roll over. Slippery plastic wrapping makes it difficult to adequately tie down the load without the use of high friction packing.



A load of sawn timber fell from a truck and hit this car



The two chains over the top of this load do not provide any tie-down on the top three middle pipes. All pipes in the load should be restrained. (See Section E.4.7, page 135).



These 3 tonne pipes dislodged when the trailer mounted a gutter at a roundabout. The chains over the top did not provide enough restraint for all pipes in the load. (Photo courtesy Prime News Tamworth).



Take care when carrying loads with a high centre of mass, because they can greatly reduce the vehicle's stability. This can lead to roll-over at relatively low cornering speeds. *(Photos courtesy Mick Simpson, Wales Truck Repairs).*





The load of large paper reels on this truck was restrained only by a tarpaulin. This does not provide adequate tie-down. The truck deck didn't have a raised coaming, which could provide sideways restraint (see inset photo).



This load of pallets was restrained only by a tarpaulin, when the truck was stopped at an inspection station. The driver attempted to restrain the load properly using rope (see photo insert) but this also was inadequate. (See page 66).



Every bag on these pallets cannot be restrained by a single strap. If tie-down is used, the pallet should be unitised using wrapping or strapping, otherwise an individual bag could dislodge (see inset photo).



Every bag and every pallet must be restrained. If the vehicle does not have sufficient or suitable restraint equipment, the load should not be carried.

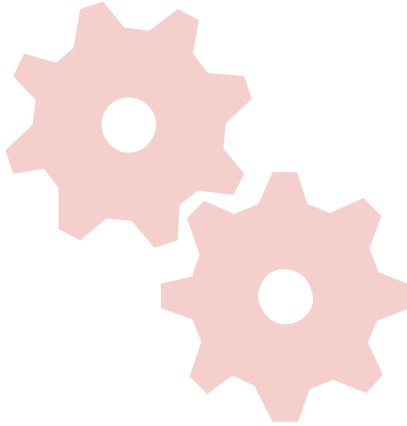


These smooth coated pipes were not adequately restrained and penetrated the driver's cabin. The front loading rack did not stop the pipes. (Photo courtesy Mick Simpson, Wales Truck Repairs).



Remember to lock rotating or movable parts on equipment and relieve any hydraulic pressure before transport. In this case the driver's operating cab on this rubber tyred crane was not locked. On a slight bend the cabin turned around and the driver of the truck could not control the imbalance. The crane hit a power pole and the driver was trapped inside the cabin of the truck because of the fallen power lines. The possibility of being electrocuted is an unusual outcome for poor load restraint. *(Photos courtesy South Australian Metropolitan Fire Service).*

Load Restraint Guide



PART 2

for

Engineers and Designers



Section F - Calculating Restraint Requirements



SECTION F

Calculating Restraint Requirements

CONTENTS	
1	PERFORMANCE STANDARDS 186
2	METHODS OF LOAD RESTRAINT 187
3	DESIGN FOR TIE-DOWN 187
3.1	Friction Force ----- 187
3.2	Friction Coefficient ----- 188
3.3	Lashing Angles ----- 189
3.4	Lashing Pre-tension ----- 190
3.5	How Many Lashings? ----- 191
	- Using Tie-down Load Tables
3.6	How Many Lashings? ----- 196
	- By Calculation
3.7	How Many Lashings? ----- 198
	- Tensioning by Load Shift
4	DESIGN FOR CONTAINING OR BLOCKING 199
5	DESIGN FOR UNITISING 200
6	DESIGN FOR DIRECT ATTACHMENT 200
6.1	Lashing Angles ----- 201
6.2	Pre-tensioned Direct Lashings ----- 203
6.3	What Strength Chains? ----- 203
	- Using Load Tables
6.4	What Strength Chains? ----- 206
	- By Calculation
7	DESIGN FOR COMBINED TIE-DOWN AND DIRECT RESTRAINT 206

Section F - Calculating Restraint Requirements

The following contains specialised information useful to engineers and designers for the design and selection of load restraint systems.

1 PERFORMANCE STANDARDS

Loads must be restrained to prevent unacceptable movement during all expected conditions of operation. The load restraint system must, therefore, satisfy the following requirements:

- (i) The load should not become dislodged from the vehicle.
- (ii) Any load movement should be limited, such that in all cases where movement occurs, the vehicle's stability and weight distribution cannot be adversely affected and the load cannot become dislodged from the vehicle.

Loads that are permitted to move relative to the vehicle include loads that are effectively contained within the sides or enclosure of the vehicle body such as:

- (a) Loads which are restrained from moving horizontally (limited vertical movement is permissible);
- (b) Very lightweight objects or loose bulk loads (limited horizontal and vertical movement is permissible);
- (c) Bulk liquids (limited liquid movement is permissible);

To achieve this, the load restraint system must be capable of withstanding the forces that would result if the laden vehicle were subjected to each of the following separately:

0.8 'g' deceleration in a forward direction,

0.5 'g' deceleration in a rearward direction,

0.5 'g' acceleration in a lateral direction,

and to 0.2 'g' acceleration relative to the load in a vertical direction.

Note: 'g' (the acceleration due to gravity), is equal to 9.81 metres/sec/sec for the purpose of these standards.



2 METHODS OF LOAD RESTRAINT

When selecting and calculating the strength of various restraint systems for loads that are contained or secured on the vehicle, consideration should be given to each of the following load restraint methods:

- (i) tie-down to clamp the load against the body structure;
- (ii) containing the load within the body structure;
- (iii) blocking the load against a body structure or attachment; and
- (iv) attaching the load directly to the body structure.

3 DESIGN FOR TIE-DOWN METHOD

Tie-down loads are restrained by friction between the load and the vehicle. Friction can also restrain items of load in contact with other items of load.

The friction is a result of the weight of the load and the extra clamping force applied by the lashings.

3.1 Friction Force

The friction force (F) can be calculated by multiplying the friction coefficient (μ) by the normal force (N) between the load and deck or any other surface the load sits on (see Figure F.1):

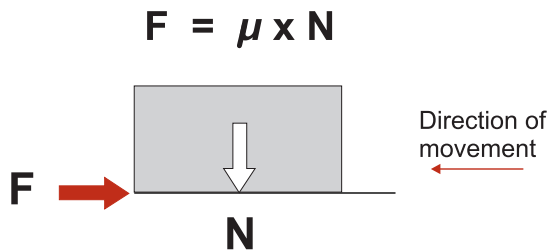


Fig. F.1

FRICTION FORMULA

The normal force N is the weight (N_w) of the load plus the tie-down force (N_L) from the combined vertical components of the lashing tensions.

$$N = N_w + N_L$$

N_L is dependent on the lashing angle(s) and the lashing tension(s) and is equal to the sum of all of the lashing tensions on each side of the load, multiplied by the angle effect E (see Figure F.3).

Section F - Calculating Restraint Requirements

3.2 Friction Coefficient

The friction coefficient (friction factor) is used to compare the load restraint friction force between two surfaces. The static friction coefficient applies before movement begins and the dynamic friction coefficient applies once movement occurs. Note that the dynamic friction coefficient is often 20% to 30% less than the static friction coefficient although it can sometimes be more than 30%. The static friction coefficient can be measured by two methods. These are a tilt test and a horizontal push/pull test, which should give the same result.

The tilt method involves tilting the deck with the load on it and measuring the angle of tilt when the load just begins to move. The friction coefficient is the tangent of the angle of tilt (θ) to the horizontal.

$$\mu = \tan \theta$$

The push/pull test involves pushing or pulling the load on a horizontal deck and measuring the friction force (F) required to start the load moving. The friction coefficient is the ratio of the friction force to the weight of the load (N_w).

$$\mu = F \div N_w$$

Where the design of a restraint system relies on the weight of the load plus lashing pre-tension, the static friction coefficient should be used. Where the design relies on the weight of the load plus tensioning by load shift (see Section F 3.7) the dynamic friction coefficient must be used. Some typical static friction coefficients are listed in Table F.1.

TYPICAL STATIC FRICTION COEFFICIENTS	
Load surfaces	Friction coefficient
Wet or greasy steel on steel	0.01 – 0.1
Smooth steel on smooth steel	0.1 – 0.2
Smooth steel on rusty steel	0.2 – 0.4
Smooth steel on timber	0.3 – 0.4
Smooth steel on conveyor belt	0.3 – 0.4
Smooth steel on rubber load mat	0.6 – 0.7
Rusty steel on rusty steel	0.4 – 0.7
Rusty steel on timber	0.6 – 0.7

Table F.1

These figures are a guide and should not be used for the design of a load restraint system. Where accurate information is not available, testing of the load should be performed or a conservative value chosen. The tests should take into account all possible combinations of surface conditions that might be encountered such as, wet, dry or greasy.



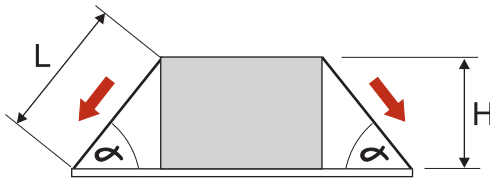
3.3 Lashing Angles

If a tie-down lashing is not vertical between the load and the tie point, its effectiveness is reduced below 100% (see Figure F.2). This is called the tie-down 'angle effect' (E).

	APPROX. ANGLE	TIE-DOWN ANGLE EFFECT	TIE-DOWN EFFECTIVENESS
	90°	1.00	100%
	60°	0.85	85%
	45°	0.70	70%
	30°	0.50	50%
	15°	0.25	25%

Fig. F.2 TIE-DOWN ANGLE EFFECT

The angle effect can be calculated by dividing the height of the load by the length of the lashing between the load and the tie point on the vehicle (see Figure F.3). The angle effect is the sine of the lashing angle (α) relative to the horizontal ($E = \sin \alpha$).



$$\text{Angle effect (E)} = \text{Height of Load (H)} \div \text{Length of Lashing (L)}$$

Fig. F.3 CALCULATING THE TIE-DOWN ANGLE EFFECT (E)

The tie-down force from each lashing is the sum of the lashing tension on each side of the load, multiplied by the angle effect.

Section F - Calculating Restraint Requirements

3.4 Lashing Pre-tension

The pre-tension is the force in the lashing provided by a mechanical tensioner or a knot.

To maintain the friction force during normal driving, the load must always remain in contact with the deck during road vibration and over bumps. To achieve this, the tie-down lashings must be pre-tensioned to provide a minimum clamping force of 20% of the weight of the load.

Average lashing pre-tensions are shown in Table F.2. Note that the figures shown in the table are operator and equipment dependent. The pre-tension on one side of a load is normally greater than the pre-tension on the other side unless the tensioner is positioned on top of the load. The differences of pretension caused by friction between the lashing and the load can be in the ratio of 4:1. In some circumstances, it is advisable to establish the pre-tension that can be achieved by the equipment, and by each operator, using in-line load indicators.

AVERAGE PRE-TENSION			
Lashing	Size	Tensioner	Pre-tension
Rope	10 mm & 12 mm	Single Hitch	50 kg
		Double Hitch	100 kg
Webbing Strap	25 mm	Hand Ratchet	100 kg
		Hand Ratchet	250 kg
	50 mm	Truck Winch	300 kg
		Hand Ratchet	300 kg
	50 mm	Hand Ratchet (push up)	600 kg
50 mm	Hand Ratchet (pull down)	600 kg	
Chain	7mm & above	Dog	750 kg
		Turnbuckle	1000 kg

Table F.2

(Also appears in Section K – Tables)

Where 75 and 100 mm webbing straps are used, their tensioners may not achieve as much pre-tension as the 50 mm tensioners, even though their lashing capacity is greater. The larger tensioners are sometimes designed for different purposes. Check their rating with the manufacturer.

The pre-tension achieved with chain tensioners is approximately the same for 7 mm, 8 mm, 10 mm and 13 mm chains.



3.5 How Many Lashings? - Using Tie-down Load Tables

The following load tables can be used to determine the maximum weight that can be restrained by each lashing. The tables include loads with or without blocking in front, on medium friction ($\mu = 0.4$) and high friction ($\mu = 0.6$) surfaces. They take into account the required minimum clamping force of 20% of the weight of the load.

If the tie-down provides the required 0.5 'g' sideways and rearward restraint it will also provide a 0.5 'g' forward restraint. The tables have also been compiled on the assumption that the blocking has the capacity to provide the additional 0.3 'g' forward restraint to meet the 0.8 'g' forward restraint requirement.

To find the number of lashings required, divide the total weight of the load by the weight that each lashing can restrain.

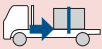
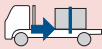
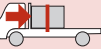
MAXIMUM WEIGHT EACH 10 OR 12 mm ROPE CAN RESTRAIN (USING SINGLE HITCH)					
FRONT OF LOAD BLOCKED?		NO		YES	
HOW MUCH FRICTION?		MEDIUM $\mu = 0.4$ (Smooth Steel on Timber)	HIGH $\mu = 0.6$ (Rubber Load Mat)	MEDIUM $\mu = 0.4$ (Smooth Steel on Timber)	HIGH $\mu = 0.6$ (Rubber Load Mat)
Minimum average rope tension 50 kg.					
ROPE ANGLE	ANGLE EFFECT (E)				
90°	1.0	100 kg	300 kg	400 kg	500 kg
approx. 60° to 90°	0.85 to 1.0	85 kg	255 kg	340 kg	425 kg
approx. 45° to 60°	0.70 to 0.84	70 kg	210 kg	280 kg	350 kg
approx. 30° to 45°	0.50 to 0.69	50 kg	150 kg	200 kg	250 kg
approx. 15° to 30°	0.25 to 0.49	25 kg	75 kg	100 kg	125 kg

Table F.3

(Also appears in Section K – Tables)

Section F - Calculating Restraint Requirements

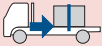
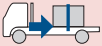
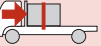
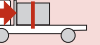
MAXIMUM WEIGHT EACH 10 OR 12 mm ROPE CAN RESTRAIN (USING DOUBLE HITCH)					
FRONT OF LOAD BLOCKED?		NO		YES	
HOW MUCH FRICTION?		MEDIUM $\mu = 0.4$ (Smooth Steel on Timber)	HIGH $\mu = 0.6$ (Rubber Load Mat)	MEDIUM $\mu = 0.4$ (Smooth Steel on Timber)	HIGH $\mu = 0.6$ (Rubber Load Mat)
Minimum average rope tension 100 kg.					
ROPE ANGLE	ANGLE EFFECT (E)				
90°	1.0	200 kg	600 kg	800 kg	1000 kg
approx. 60° to 90°	0.85 to 1.0	170 kg	510 kg	680 kg	850 kg
approx. 45° to 60°	0.70 to 0.84	140 kg	420 kg	560 kg	700 kg
approx. 30° to 45°	0.50 to 0.69	100 kg	300 kg	400 kg	500 kg
approx. 15° to 30°	0.25 to 0.49	50 kg	150 kg	200 kg	250 kg

Table F.4

(Also appears in Section K – Tables)







MAXIMUM WEIGHT EACH 50 mm WEBBING STRAP CAN RESTRAIN					
FRONT OF LOAD BLOCKED?		NO		YES	
HOW MUCH FRICTION?		MEDIUM $\mu = 0.4$ (Smooth Steel on Timber)	HIGH $\mu = 0.6$ (Rubber Load Mat)	MEDIUM $\mu = 0.4$ (Smooth Steel on Timber)	HIGH $\mu = 0.6$ (Rubber Load Mat)
Minimum average strap tension 300 kg.					
STRAP ANGLE	ANGLE EFFECT (E)				
90°	1.0	600 kg	1800 kg	2400 kg	3000 kg
approx. 60° to 90°	0.85 to 1.0	510 kg	1530 kg	2040 kg	2550 kg
approx. 45° to 60°	0.70 to 0.84	420 kg	1260 kg	1680 kg	2100 kg
approx. 30° to 45°	0.50 to 0.69	300 kg	900 kg	1200 kg	1500 kg
approx. 15° to 30°	0.25 to 0.49	150 kg	450 kg	600 kg	750 kg

Table F.5

(Also appears in Section K – Tables)

Section F - Calculating Restraint Requirements





MAXIMUM WEIGHT EACH 8 mm CHAIN CAN RESTRAIN					
FRONT OF LOAD BLOCKED?		NO		YES	
HOW MUCH FRICTION?		MEDIUM $\mu = 0.4$ (Smooth Steel on Timber)	HIGH $\mu = 0.6$ (Rubber Load Mat)	MEDIUM $\mu = 0.4$ (Smooth Steel on Timber)	HIGH $\mu = 0.6$ (Rubber Load Mat)
Minimum average chain tension 750 kg.					
CHAIN ANGLE	ANGLE EFFECT (E)				
90°	1.0	1500 kg	4500kg	6000 kg	7500 kg
approx. 60° to 90°	0.85 to 1.0	1275 kg	3825 kg	5100 kg	6375 kg
approx. 45° to 60°	0.70 to 0.84	1050 kg	3150 kg	4200 kg	5250 kg
approx. 30° to 45°	0.50 to 0.69	750 kg	2250 kg	3000 kg	3750 kg
approx. 15° to 30°	0.25 to 0.49	375 kg	1125 kg	1500 kg	1875 kg

Table F.6

(Also appears in Section K – Tables)



Example:

The following example shows how to find the number of lashings using the load tables F.3, F.4, F.5, F.6:

"A vehicle is carrying an 8 tonne load. The load is blocked against a strong headboard (minimum capacity 30% of the weight of the load). The load is supported on timber dunnage that provides medium friction. The height of the load is 1.2 metres and the length of the lashing between the top of the load and the tie point is 1.6 metres on each side. How many ropes, webbing straps or chains are required?"

The angle effect (E), is 1.2 metres (H) divided by 1.6 (L) metres;

ie. the angle effect, $E = 1.2 \div 1.6 = 0.75$

Refer to the tables:

- The angle effect is 0.75, therefore the third row (0.70 to 0.84) applies.
- The friction is classed as medium and the load is blocked, therefore the third column of weight applies.
- The maximum weight that can be restrained by each lashing can then be selected (third row, third column).

To find the number of lashings required, divide the weight of the load by the weight selected:

- A rope with a single hitch will restrain 280 kg. (Table F.3)
The number of ropes required is $8000 \div 280 = 29$
- A rope with a double hitch will restrain 560 kg. (Table F.4)
The number of ropes required is $8000 \div 560 = 15$
- A webbing strap will restrain 1680 kg. (Table F.5)
The number of straps required is $8000 \div 1680 = 5$
- A chain will restrain 4200 kg. (Table F.6)
The number of chains required is $8000 \div 4200 = 2$

Section F - Calculating Restraint Requirements

3.6 How Many Lashings? - By Calculation.

The number of lashings in the above example (with a weight of 8000 kg and a friction coefficient of 0.4) can be calculated using the actual lashing angle. This may result in fewer lashings being required.

The load must be restrained to 0.8 'g' in the forward direction. As the front of the load is blocked, the tie-down needs only to provide 0.5 'g' forward, sideways and rearward restraint, if the blocking is capable of providing the additional 0.3 'g' forward restraint.

Therefore, the amount of tie-down restraint required is,

$$F = 0.5 \text{ 'g' } \times N_w = 0.5 \times 8000 = 4000 \text{ kg.}$$

The friction force F_w from the weight of the load is,

$$F_w = \mu \times N_w = 0.4 \times 8000 = 3200 \text{ kg.}$$

The friction force F_L required from the tie-down lashings is the difference between the total restraint force required and the friction force from the weight of the load,

$$F_L = F - F_w = 4000 - 3200 = 800 \text{ kg.}$$

The required tie-down force N_L is calculated by dividing the friction force F_L by the friction factor μ ,

$$N_L = F_L \div \mu = 800 \div 0.4 = 2000 \text{ kg.}$$

As the lashings are not vertical, the angle effect (E) must be calculated,

$$E = H \div L = 1.2 \div 1.6 = 0.75.$$

The tie-down force from one lashing is calculated by multiplying twice the lashing pretension (T), by the angle effect (E).

(Note: A factor of two is used because the lashing clamps on both sides of the load.)

In this example, tie-down force from one lashing,

$$2T \times E = 2T \times 0.75 = 1.5T.$$

To obtain the number of lashings (n) required, divide the required tie-down force N_L by the tie-down force from one lashing,

$$n = 2000 \div 1.5T = 1333 \div T.$$



Taking into account differences in tension on each side of the load, typical average tie-down pre-tensions are:

- rope with a single hitch, 50 kg
- rope with a double hitch, 100 kg
- webbing strap, 300 kg
- chain. 750 kg

Therefore, the number of lashings are:

- rope with a single hitch, $1333 \div 50 = 27$
- rope with a double hitch, $1333 \div 100 = 14$
- webbing strap, $1333 \div 300 = 5$
- chain. $1333 \div 750 = 2$

It is now necessary to check that the tie-down lashing pre-tension provides a minimum clamping force of 20% of the weight of the load.

The total tie-down force (N_L) must be at least equal to 20% of the weight of the load (N_W),

$$N_L \div N_W = 2000 \div 8000 = 0.25 \text{ (or 25\%)},$$

which is greater than the 20% N_W required.

3.7 How Many Lashings? - Tensioning By Load Shift

Specialised load restraint systems can be designed to incorporate load shift to increase lashing tension. As the load shifts forward under heavy braking, the lashings stretch and clamp the load harder against the deck thus increasing the friction force.

These systems must allow for very small forward load shifts only and must be capable of absorbing the energy required to stop the moving load.

Sideways movement must be prevented to avoid degrading stability. Where the system is restrained by tie-down in the sideways and rearwards directions, the required restraint must be achieved using the clamping forces resulting only from the weight of the load and the initial lashing pre-tension.

To allow the lashing to stretch under forward load shift, the lashing must be prevented from slipping on the load by:

- attaching it to the load;
- passing it through the load;
- passing it in front of an obstruction or protrusion on the load; or
- providing sufficient friction between the load and lashing.

The forward load shift must be limited by controlling the amount of stretch in the lashings. The lashings must therefore have a high stiffness or low stretch characteristic. Steel chain and steel strapping can be suitable, whereas **rope and webbing** are much more elastic, allowing too much load shift and **should not be used unless part of a properly designed load restraint system**.

When multiple lashings are used, there is a possibility that one lashing might reach its lashing capacity well before the rest and break during load shift. This could occur because of many factors including, uneven slippage of the lashing on the load; uneven pre-tension of the lashings; mixed sizes of lashings; a large number of lashings; and uneven flexibility of both the vehicle and load. The system design must account for these factors. As these systems are unpredictable by design, they must be validated by physical testing to 0.8 'g' in the forward direction.

The friction force (F) can be calculated by multiplying the dynamic friction coefficient (μ_p) by the force (N) between the load and deck. The force N is the weight of the load plus the tie-down force.

The tie-down force from each lashing is the sum of the lashing tension on each side of the load, multiplied by the angle effect. The tension in any lashing must not exceed the manufacturers' lashing capacity.



4 DESIGN FOR CONTAINING OR BLOCKING

When designing for containing (see Section J, page 247 for definition of Contained Load and Section E, page 140 for more information) or blocking, if there is no tie-down (ie indirect restraint) to resist the vertical 0.2 “g” nominated in the Performance Standards, the effect of friction between the deck and the load and between layers of load must be neglected in assessing restraint capacity. This is because when the vehicle hits a bump, the resulting jolt can break the friction contact between the items of load. Even a load resting on very high friction rubber load mat can “walk” to the low side of the trailer during a journey, if it is not tied down.

The effect of a raised side coaming rail must be neglected when assessing restraint capacity, if the load is not tied down as the load could jump over the coaming rail in a bump.

When designing vehicle structures such as headboards, loading racks, barriers, curtain sides, side gates and drop sides the following ‘loading cases’ should be taken into account:

Stable single load	restraint forces act at the lower edge of a free-standing structure or are distributed over the height of the load with a fully supported structure.
Unstable single load	restraint forces are distributed unevenly over the height of the load.
Stacked load	restraint forces are distributed over the height of each item of load
Point load	restraint force acts at point of contact
Loose bulk load	restraint forces are evenly distributed over the height of the load
Impact load	restraint forces could be very high (simulation or testing required).

The stability of each item of load can be determined by reference to Section B.3, page 43.

A single load is a single item or a unitised number of items that are placed in a single layer on the deck. Such unitised loads are, for example, pallets with the load wrapped and strapped to the pallet or strapped packs such as bricks. Items stacked loosely on a pallet cannot be considered a single load, no matter how much friction is between them. They must be considered as separate loose single items.

A stacked load is a number of loose single items or unitised packs of items, stacked on top of each other and includes pallets stacked two-high, loose cartons and many stretch wrapped pallet loads.

Loose loads that cannot be stacked are considered as a loose bulk load.

Section F - Calculating Restraint Requirements

To satisfy the Performance Standards the side restraint system must not only prevent the load dislodging from the vehicle, it must not allow the load to shift in such a way that makes the vehicle unstable.

Remember, the higher the centre of mass of the load, the greater is the effect of any load shift on the stability of the vehicle. For example, if a relatively lightweight loose bulk volume load with a centre of mass 1500 mm above the trailer deck shifts sideways during a sudden swerve, bulging a side curtain outwards, the effect on the vehicle stability could be much more severe than a single level of heavy pallets moving 50 mm to 100 mm sideways.

The testing requirements for loads that are not tied down, are contained in Section I (How to Certify a Load Restraint System).

5 DESIGN FOR UNITISING

Pallets and packs can be loaded against a headboard or supported by other load. The integrity of a pallet or pack can be tested, as follows:

- restrain the pallet or pack in the same way that it would be transported;
- where the pallet or pack will be supported by a headboard or by other load to a headboard, tilt the pallet or pack to 30 degrees (equivalent to a minimum horizontal acceleration of 0.5 'g');
- where the pallet or pack will not be supported by a headboard or supported by other load to a headboard, tilt the pallet or pack to 53 degrees (equivalent to a minimum horizontal acceleration of 0.8 'g');
- if the packing arrangement or layers in the pallet or pack are not symmetrical when viewed from above, rotate the pallet or pack 90 degrees and repeat the above tests.

The pallet or pack should not show any slippage or significant distortion during these tests.

6 DESIGN FOR DIRECT ATTACHMENT

Where a load is directly attached to a vehicle, the following two cases should be considered:

- *The restraint system provides no additional clamping force to the vehicle.*

The friction forces between the load and the deck should not be considered in this case eg. shipping container twistlocks.

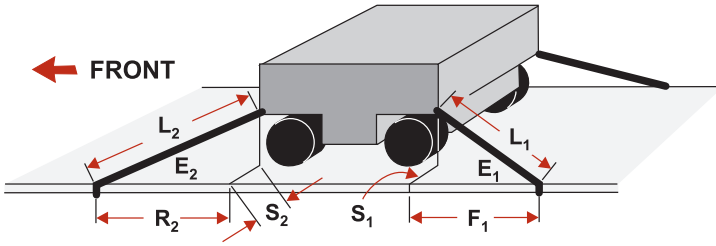
- *The restraint system is pre-tensioned or angled to provide additional clamping force to the vehicle.*



When load movement produces increased tension in lashings which are angled downward, additional clamping forces result. The friction forces between the load and the deck can be added to the direct restraint forces eg. sideways restraint of steel tracked equipment.

6.1 Lashing Angles

The angle of the lashing determines the tension that develops in the lashing to restrain a load. The effectiveness of direct lashings (the angle effect E) can be calculated by measuring the horizontal distance in the direction of restraint, from the tie point on the load to the tie point on the vehicle and dividing it by the length of the lashing (see Figure F.4).



For lashing L_1

Angle Effect (E_1) Forwards = Distance (F_1) \div Length of Lashing (L_1)

Angle Effect (E_1) Sideways = Distance (S_1) \div Length of Lashing (L_1)

For lashing L_2

Angle Effect (E_2) Rearwards = Distance (R_2) \div Length of Lashing (L_2)

Angle Effect (E_2) Sideways = Distance (S_2) \div Length of Lashing (L_2)

Fig F.4 **CALCULATING THE DIRECT LASHING 'ANGLE EFFECT'**

Section F - Calculating Restraint Requirements

As direct lashings become more vertical, they become less effective in providing horizontal restraint (see Figure F.5).

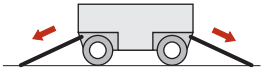
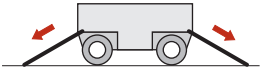
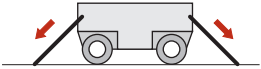
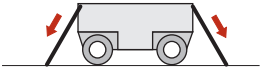
	ANGLE	DIRECT LASHING ANGLE EFFECT	DIRECT LASHING EFFECTIVENESS
	25°	0.90	90%
	30°	0.86	86%
	45°	0.70	70%
	60°	0.50	50%

Fig F.5 **ANGLED DIRECT LASHINGS - HOW EFFECTIVE?**

A recommended angle for direct lashings is a slope of 1 in 2 or approximately 25 degrees to the horizontal (see Figure F.6). The lashings will then have an effectiveness of 90% (an angle effect of 0.9).

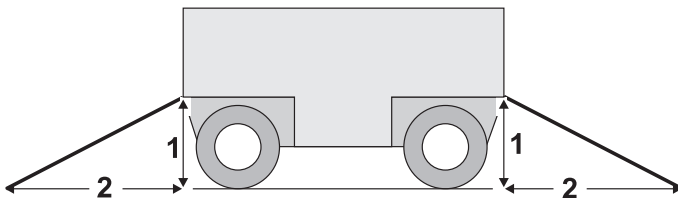


Fig F.6 **RECOMMENDED ANGLE FOR DIRECT LASHINGS**



6.2 Pre-tensioned Direct Lashings

Where a load is restrained by pre-tensioned direct lashings that act in opposite directions, the amount of pre-tension in the lashings can reduce their capacity to restrain the load.

When the load is subjected to a force in one direction, the tension in the lashings opposing the force is increased, whilst the tension in the opposite lashings is reduced. This effect varies depending on the type, length, size or angle of the lashings.

If those lashings where tension has increased are stiffer than the opposite lashings, the force in them will be greater than needed to restrain the load. This is because the more elastic opposite lashings remain partly tensioned.

This effect is more likely to be experienced when different types of lashings such as webbing and chain are used together. Lashings of equal elasticity should be used and should be symmetrically placed to overcome this effect.

6.3 What Strength Chains? - Using Load Tables

The following load tables (see Tables F.7 and F.8) allow selection of the minimum size of chain required when two chains are used to prevent movement in a particular direction. The lashing capacity is listed for loads from 100 kg to 30 tonnes.

The required lashing capacity is greater when:

- restraining heavier loads
- restraining loads in the forward direction
- lashings are angled ineffectively (not opposite to direction of motion).



Section F - Calculating Restraint Requirements

This table shows the minimum strength (lashing capacity) required for each of two chains directly restraining forward movement.

MINIMUM LASHING CAPACITY - DIRECT RESTRAINT FORWARDS (0.8W) USING TWO CHAINS			
Mass of Load (kilograms)	Minimum Lashing Capacity		
	E = 0.85 to 1.0	E = 0.70 to 0.84	E = 0.50 to 0.69
100	48	58	80
200	95	115	160
300	142	172	240
400	189	229	320
500	236	286	400
750	353	429	600
1000	471	572	800
1500	706	958	1200
2000	942	1143	1600
(tonnes)			
3	1.5	1.8	2.4
4	1.9	2.3	3.2
5	2.4	2.9	4.0
6	2.9	3.5	4.8
7	3.3	4.0	5.6
8	3.8	4.6	6.4
9	4.3	5.2	7.2
10	4.8	5.8	8.0
11	5.2	6.3	8.8
12	5.7	6.9	9.6
13	6.2	7.5	10.4
14	6.6	8.0	11.2
15	7.1	8.6	12.0
16	7.6	9.2	12.8
17	8.0	9.8	13.6
18	8.5	10.3	14.4
19	9.0	10.9	15.2
20	9.5	11.5	16.0
21	9.9	12.0	16.8
22	10.4	12.6	17.6
23	10.9	13.2	18.4
24	11.3	13.8	19.2
25	11.8	14.3	20.0
26	12.3	14.9	20.8
27	12.8	15.5	21.6
28	13.2	16.0	22.4
29	13.7	16.6	23.2
30	14.2	17.2	24.0

Table F.7

(Also appears in Section K – Tables)



This table shows the minimum strength (lashing capacity) required for each of two chains directly restraining sideways or rearwards movement:

MINIMUM LASHING CAPACITY - DIRECT RESTRAINT SIDEWAYS OR REARWARDS (0.5W) USING TWO CHAINS			
Mass of Load	Minimum Lashing Capacity		
(kilograms)	E = 0.85 to 1.0	E = 0.70 to 0.84	E = 0.50 to 0.69
100	30	36	50
200	59	72	100
300	89	108	150
400	118	143	200
500	148	179	250
750	221	268	375
1000	295	358	500
1500	442	536	750
2000	589	715	1000
(tonnes)			
3	0.9	1.1	1.5
4	1.2	1.5	2.0
5	1.5	1.8	2.5
6	1.8	2.2	3.0
7	2.1	2.5	3.5
8	2.4	2.9	4.0
9	2.7	3.3	4.5
10	3.0	3.6	5.0
11	3.3	4.0	5.5
12	3.6	4.3	6.0
13	3.9	4.7	6.5
14	4.2	5.0	7.0
15	4.5	5.4	7.5
16	4.8	5.8	8.0
17	5.0	6.1	8.5
18	5.3	6.5	9.0
19	5.6	6.8	9.5
20	5.9	7.2	10.0
21	6.2	7.5	10.5
22	6.5	7.9	11.0
23	6.8	8.3	11.5
24	7.1	8.6	12.0
25	7.4	9.0	12.5
26	7.7	9.3	13.0
27	8.0	9.7	13.5
28	8.3	10.0	14.0
29	8.6	10.4	14.5
30	8.9	10.8	15.0

Table F.8

(Also appears in Section K - Tables)

Section F - Calculating Restraint Requirements

Example:

The following example shows how to find the number of chains using the load tables:

“Find the minimum Transport Chain size that can be used to restrain an 8 tonne steel wheeled roller on a steel deck (no friction) using two chains to prevent forward movement. The length of chain (L_1) between tie points is 2.0 metres. The distance between the tie points (F_1) measured along the vehicle is 1.5 metres (refer to Figure F.4)”.

The angle effect is 1.5 metres (F_1) divided by 2.0 (L_1) metres, i.e. $E_1 = 0.75$

Refer to Table F.7 and note that as the angle effect is between 0.7 and 0.84, the third column applies.

Read the lashing capacity in the centre column in the 'Mass of Load' 8 tonne row. The minimum lashing capacity is 4.6 tonnes.

From Table C.4, or chain manufacturers' specifications, select chains each with a lashing capacity of at least 4.6 tonnes.

Therefore, the two chains must be at least either 10 mm Transport Chain using claw hooks, or winged grab hooks or 13 mm Transport Chain using plain grab hooks.

6.4 What Strength Chains? - By Calculation

The strength of the chains in the above example (with a weight of 8 tonne) can be calculated using the actual lashing angle. This may result in smaller size chains being required.

The angle effect in the forward direction, $E = 0.75$.

The required forward restraint (0.8 'g') is, $0.8 \times 8000 \text{ kg} = 6400 \text{ kg}$

Each chain must provide, $6400 \text{ kg} \div 2 = 3200 \text{ kg}$ of restraint (on the assumption that any tension in the opposite chains has slackened to zero).

Because of the angle effect the chain tension is;

$3200 \text{ kg} \div E = 3200 \text{ kg} \div 0.75 = 4267 \text{ kg}$.

From Table C.4, or chain manufacturers' specifications, select chains each with a lashing capacity of at least 4.267 tonnes.

Therefore two 10 mm Transport Chains using either claw hooks, winged grab hooks or grab hooks are the minimum required.

7 DESIGN FOR COMBINED TIE-DOWN AND DIRECT RESTRAINT

There are many load restraint systems where both tie-down and direct restraint can combine to meet the performance standards.

The methods of calculation outlined above can be used for combined systems.



Cotton module tilt test in side direction.



Cotton module tilt test for rearward and forward direction.



Load testing large hay bales (2.4 m x 1.2 m x 1.2 m). In this case only one webbing strap per row was used and the bales collapsed.



The solution was to use two straps and steel edge protectors. This allowed the bales to stay on the fully tilted truck. Without the edge protectors the webbing straps cut through the bales. With the protectors in place the straps could be fully tensioned.



SECTION G

Vehicle Structures

CONTENTS		
1	TIE-RAILS AND LOAD ANCHOR POINTS	211
2	WINCH TRACKS	211
3	CONTAINER TWIST LOCKS	212
4	HEADBOARDS, LOADING RACKS AND BARRIERS	212
5	CURTAIN SIDES, SIDE GATES AND DROP SIDES	212
6	STAKES, PINS, PEGS, POSTS AND STANCHIONS	213
7	CRADLES, CHOCKS, A-FRAMES AND TRESTLES	214
8	CONTAINMENT BODIES	216
9	TANKS AND TANKERS	216
10	LATCHES, LOCKS AND HINGES	217
11	LOADING EQUIPMENT	218
12	STORAGE OF EQUIPMENT	218
13	LOAD DISTRIBUTION	218

Section G - Vehicle Structures

This Section contains general vehicle body design requirements to enable the appropriate selection by manufacturers, suppliers and vehicle owners.

Vehicle structures considered in this Section include fixed and movable restraint structures, and fixed anchor points for securing devices. Restraint structures include tanks, tipping bodies, van bodies, sided bodies, headboards, bulkheads, coaming rails, loading racks, gates, doors and side curtains. Anchor points include tie rails, tie-down attachment points and twist locks.

The design requirements for special structures to prevent a load penetrating the vehicle cabin in the event of an accident or the failure of any load restraint device, can exceed the Performance Standards and are beyond the scope of this guide.

Section B 'Arranging Loads on Vehicles', and Section C 'Restraining Loads on Vehicles' contain the requirements which should be taken into account when considering vehicle suitability and the use of vehicle structures.

Section F 'Calculating Restraint Requirements', contains the methods of determining the forces exerted on vehicle structures.

The National Code of Practice Heavy Vehicle Modifications (see Section J) contains other requirements which should be taken into account when considering body and anchor point attachments. (*Vehicle Standards Bulletin No. 6*).

All vehicle structures and their attachment to the vehicle chassis must be strong enough to provide the load restraining forces.

The design of any supporting structure must take into account the torsional and bending strength and stiffness of the vehicle structure. Any recommendations of the vehicle manufacturer must be taken into account.

The mounting of anchor points should not weaken the vehicle chassis or body structure. Drilling or welding of chassis flanges is not permitted without approval of the vehicle manufacturer.



1 TIE-RAILS AND LOAD ANCHOR POINTS

Lashings can be attached to a vehicle at any point along a tie-rail or at fixed anchor points such as lashing rings (see Page 233), hooks, tie-rail support points.

These attachment points should have a suitable rating for the intended operational use of the vehicle and methods of load restraint to be used.

To withstand the restraint forces applied by lashings in normal circumstances, tie rails and anchor points should be capable of providing adequate restraint in the direction of any attached lashing.

The maximum restraint force for tie-down applications where load shift cannot occur is the maximum pre-tension force exerted by the operator when tensioning the lashings. Typical forces are listed in Table C.2 on page 65 of this guide.

The maximum restraint force for direct restraint applications (mobile equipment) and tie-down applications where load shift can occur (tested and certified applications) is the effective Lashing Capacity of the lashing (usually chain). For example: 8 mm Transport chain has Lashing Capacity of 3.8 tonnes (some 4 tonnes) and its strength is de-rated to 2.85 tonnes when passed around edges, coaming rails etc.

Lashing points on vehicles carried on Roll On-Roll Off vessels and on rail rollingstock require specific ratings for the application.

See Section J for details of various standards that cover tie-rails and load anchor points.

2 WINCH TRACKS

The design of winch tracks must take into account the magnitude and direction of the lashing force, and spacing of the track supports.

The rated track capacity should be clearly and permanently marked on the vehicle.

3 CONTAINER TWIST LOCKS

Container twist locks must be compatible with the dimensional requirements of AS/NZS 3711 series of standards for freight containers (see Section J).

Where the twist lock support structure is only designed for restraining empty containers or other light loads, the maximum weight should be clearly marked on the vehicle. Failure to mark the weight could have serious consequences if an accident occurred.

4 HEADBOARDS, LOADING RACKS AND BARRIERS

The use of headboards, loading racks and barriers can reduce the number of tie-down lashings required for forward restraint.

If the load is tied down to 0.5'g' in the forward, sideways and rearward direction, the front structure can provide the additional 0.3'g' required for forward restraint. In such cases, the strength of the front structure does not need to be as great as that required for an otherwise unrestrained load.

When designing headboards, loading racks and barriers, the 'loading cases' described in Section F.4, page 199 'Design for containing or blocking' should be taken into account.

The cantilevered structure of a headboard or movable barrier can be easily modified to a supported structure by chaining each side of the headboard or barrier to the tie rail support points. The use of a single long chain from tie-rail to tie-rail around the front of the structure will absorb shock more effectively than two shorter chains. Details are shown in Section C 4.4, page 73.

The chain should be kept below 30 degrees to the horizontal to maintain its effectiveness and to minimise the vertical force at the chain support points. An 8 mm transport chain can provide a total additional restraint of at least 6.5 tonnes angled at 30 degrees on both sides.

5 CURTAIN SIDES, SIDE GATES AND DROP SIDES

When designing curtain sides, side gates and drop sides the 'loading cases' described in Section F.4 page 199 'Design for containing or blocking' should be taken into account.

The amount of sideways deflection of any part of a curtain, gate or drop-side should be limited to 100 mm for determining its load restraint capacity at 0.5 'g' sideways.

Where vehicles with curtain sides are designed for load restraint purposes (with or without gates), the system should be tested and certified in accordance with requirements set out in Section F - Calculating Restraint Requirements and Section I - How to Certify a Load Restraint System.

Side gates and loading racks that depend on interlinking with adjacent gates for their strength and stability, should be positively locked or tied into position without relying on tie-down lashings or tarpaulins to prevent them from lifting or bowing.

Side gates supported sideways at the top by curtains should be positively locked in position to prevent them dislodging from the bottom coaming rail supports over bumps or rough roads.



Where side gates and drop-sides are designed to restrain a load without any tie-down, the top of each side should be well above the base of any item of load to be carried. This is to ensure that loads do not become dislodged on bumps or rough roads, especially when cornering.

When evaluating the suitability of sides for a particular application, the manufacturer, supplier and vehicle owner should take into account the following factors:

- The height of the load (whether the load is on the deck or stacked).
- The type of load (whether the load is on wheels, 'bouncy', or likely to be affected by air flow).
- The type of suspension (vehicles with stiff suspensions will require higher gates or sides, especially when travelling near empty).
- The rear overhang of the body (long rear overhangs can magnify the effect of bumps and rough roads).

6 STAKES, PINS, PEGS, POSTS AND STANCHIONS

Vehicles regularly carrying loose plate, sheets, boards, rods, pipes and other similar items should be fitted with pockets along the sides and across the deck in various positions so that stakes, pins, pegs, posts or stanchions can be fitted where required to provide direct restraint.

Any removable stake, pin, peg, post and stanchion must be designed to prevent it from becoming dislodged during a journey by adequate engagement length in its socket or by the use of a positive locking method.

Separate detachable frames which are adjustable in position with provision for stakes, pins, pegs, posts or stanchions can be used as an alternative to fixed pockets on the vehicle.

7 CRADLES, CHOCKS, A-FRAMES AND TRESTLES

Cradles should be designed to prevent cylindrical objects from rolling.

If the cradle prevents the cylinder from rolling, fewer lashings may be required or lower strength lashings may be used.

Cylindrical items will not roll if the ratio of the distance between the cradle/cylinder contact lines (W) to the diameter of the cylinder (D) is equal to, or greater than 5:8 which is equivalent to a wedge angle of 39 degrees (see Figure G.1).

Thus, to prevent rolling:

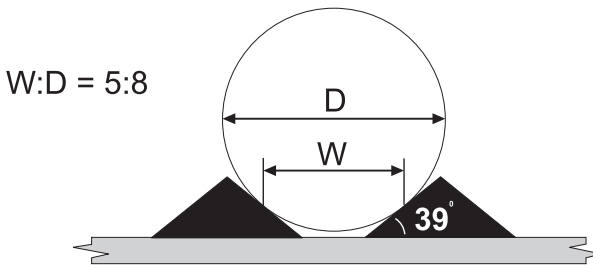


Fig G.1

CRADLE DIMENSIONS

Where cradles, chocks, A-frames and trestles are fabricated from metal, designers should take into account the low friction between them and metal decks (and also, the low friction between the load and the metal frame). Provision should be made for capping or facing with timber or rubber to increase the friction.

Cradles can be designed to allow them to be adjusted for different sized coils, to prevent any tendency to roll and therefore to reduce the forces in the lashings. The cradles should be adjusted so the coil rests on the edges and not the bottom of the cradle.

Where tie-down lashings are used to restrain loaded cradles, A-frames or trestles, the direction of the lashings should be as vertical as possible between the cradle or trestle contact point and vehicle tie point (see Figure G.2).

Where direct lashings are used to restrain loaded cradles, A-frames or trestles, the direction of the lashings should be opposite to the expected direction of movement which would result if the load were unrestrained. For example, sideways facing chains attached to a trestle have no load restraint capacity in the forward direction.

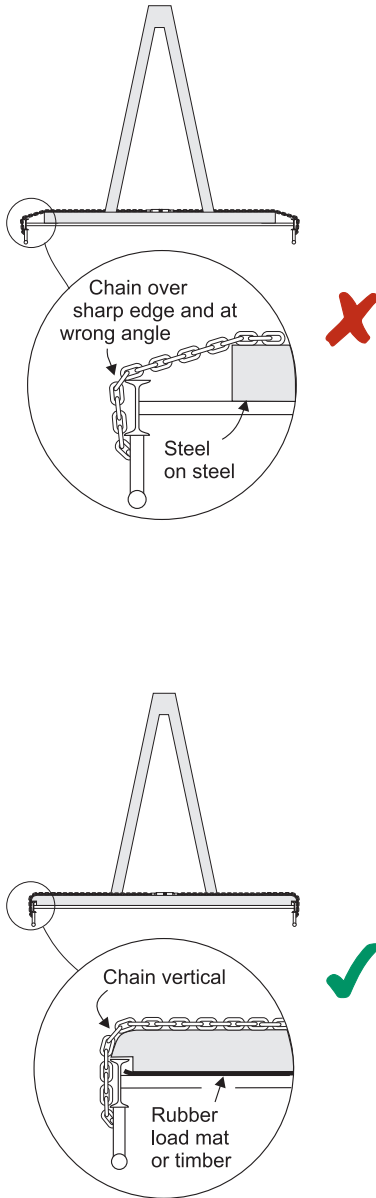


Fig G.2

A-FRAME RESTRAINT

Section G - Vehicle Structures

Chocks should have high friction contact surfaces and provision for attaching lashings to secure the chocks onto the vehicle. Sandbags and sawdust bags are only suitable for use as chocks during loading and unloading, but not during transport, because they can deform and move under road-induced vibration. When carried, these bags must be restrained on the vehicle as they are also an item of load.

8 CONTAINMENT BODIES

Bodies designed to contain loose bulk loads or general freight without the need for securing devices must not allow the load to become dislodged. Any movement of the load must not reduce the stability of the vehicle.

Heavy individual loads are generally not suitable for restraint by containment unless the restraining structure prevents all horizontal load movement.

Open bodies designed for loose bulk loads should be fitted with covers to prevent load loss from the effects of air flow and rough roads. If the covers are fitted with fixed tracks, winches or handles, they must not make the vehicle be overwidth or overlength.

9 TANKS AND TANKERS

Tanks and tankers can be designed for bulk liquids and finely divided solids including powders.

Where tanks or tankers are required to travel partially full, baffles and compartments should be fitted to prevent any movement of the contents that could cause the vehicle to become unstable especially during cornering.

The load restraint design forces should take into account the dynamic nature of the load eg. the effect of liquid surge in all directions.

All tanks should be designed so that the centre of mass of the laden vehicle is as low as possible.

Loaded ISO tank containers should be transported on low trailers (see Figure G.3).

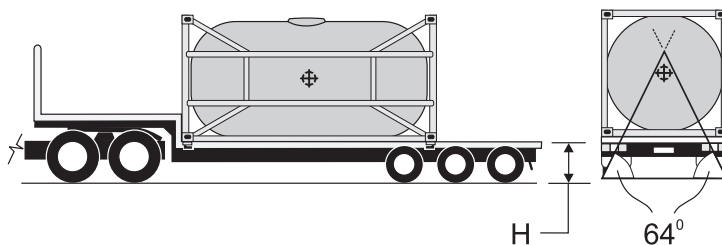


Fig. G.3 ISO TANK CONTAINER ON A 'DROP-DECK' TRAILER



The height of the centroid of the tank container cross-section at the tank half length should fall within an isosceles triangle having a base length at ground level equal to the overall width between the outside tyres of the main load-bearing axle groups and base angles not exceeding 64 degrees. (See Section J AS/NZS 2809.1 Road Tank Vehicles for Dangerous Goods - General Requirements).

This requirement will be met if the height (H) from the ground to the bottom of the container corner casting, measured when fully laden, is no greater than 1100 mm. Table G.1 contains measurements that give a stability angle of 64 degrees.

TANK HEIGHT FOR STABILITY						
Width between the outside of the outside tyres (mm)	2300	2400	2425	2450	2475	2500
Maximum height of tank centroid (mm)	2360	2460	2490	2510	2535	2560

Table G.1

Demountable tanks should be secured by twist locks or other positive locking devices. Alternatively, lashings can be used, provided that both the tank and vehicle are equipped with suitable anchor points. If direct lashings are used, each anchor point should be positioned on the support structure so that the lashing angle is low (direct lashing angle effect is high). If tie-down is used, the tank should be placed on timber or rubber load mat and each anchor point should be positioned on the support structure so that the tie-down lashing angle is high (tie-down lashing angle effect is high).

The Australian Code for the Transport of Dangerous Goods by Road and Rail (see Section J) contains construction requirements for tanks and tank vehicles carrying dangerous goods.

10 LATCHES, LOCKS AND HINGES

Latches, locks, hinges and other attachments should be designed to prevent them separating by road induced vibration and impact loads. These items can suffer fatigue cracking if not properly designed. If failure occurs, the load can dislodge from the vehicle. An unsecured swinging door or gate can cause severe injury and damage.

If doors, gates and drop sides are designed for travel in the open position, the vehicle must meet the legal length and width limits when they are both open and closed. They must be capable of being positively restrained when travelling so as to stop them swinging out into the path of other road users.

11 LOADING EQUIPMENT

Where loading equipment such as side loaders and crane stabilising legs protrude outside the vehicle for loading, it should be designed so that the vehicle cannot be moved or an audible and visual indicator operates inside the cabin, if the equipment is not retracted into its travel position.

12 STORAGE OF EQUIPMENT

Where loose restraint equipment, such as lashings, dunnage, chocks, sandbags, stakes, blocks, beams and bars are not in use, special provision should be made for securing or containing this loose material. Purpose-built bins or boxes should be fully enclosed, or if open, should be deep enough to allow adequate height above the base of any loose object to prevent it dislodging on bumps or rough roads.

13 LOAD DISTRIBUTION

To maintain safe steering performance, the weight on a single steer axle of a rigid vehicle or prime mover should be at least 20% of the total vehicle weight over all axles.

For a twin-steer truck or prime mover, the total weight on the steer axles should be at least 30% of the total vehicle weight over all axles.

To maintain vehicle stability, the weight on the rear axle(s) of a rigid vehicle or prime mover should be at least 40% of the total vehicle weight over all axles.

To determine axle weight resulting from the position of a load, either weigh the vehicle or refer to a load distribution graph.

A load distribution graph shows the maximum load that can be carried at each position of the centre of mass of the load along the vehicle, without exceeding legal axle load limits and without reducing the weight on the steer axle(s) below the safe limit. Graphs should be obtained from the vehicle or body manufacturer or a vehicle engineer.



Figure G.4 is a load distribution graph for a typical three-axle rigid truck with an 8-metre tray and having a tare weight of 9 tonnes. The front and rear legal axle load limits are taken to be 6 tonnes and 16.5 tonnes respectively.

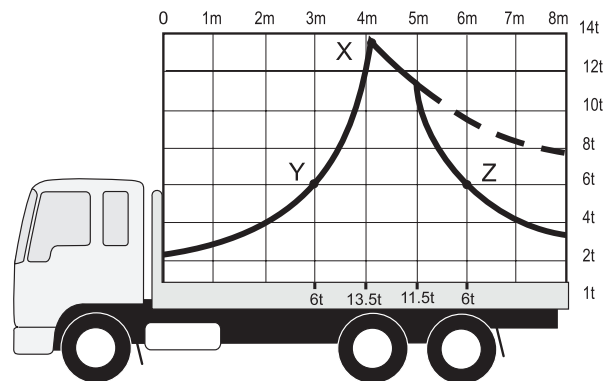


Fig G.4 **TYPICAL LOAD DISTRIBUTION GRAPH**

For example, to correctly position a load of 6 tonnes on the vehicle:

- (i) find where the horizontal line through '6t' on the graph crosses the unbroken curved lines (the two points 'Y' and 'Z' on the graph);
- (ii) using the top scale (0 → 8 m) determine the distance of each of these two points from the headboard, ie. 3 m and 6 m; and position the 6-tonne load with its centre of mass anywhere between these two points.

Note: In this example the centre of mass of the maximum allowable load, 13.5 tonnes, can be placed at only one position, 'X', about 4.1 metres along the tray.

Note also that loads above half the maximum load (6.75 tonnes) are limited to a narrow range of positions along the tray.

Figure G.4 also shows the vehicle's minimum front axle loading required for safe steering (weight on steer axle at least 20% of the total of all axles), by showing a much reduced weight which can be carried behind the rear axle group. The unbroken line between the 5 metre and 8 metre positions shows the range of weights which can be carried whilst maintaining safe steering. Those allowable weights (limited by safe steering requirements) are much less than the weights that could be carried without overloading the axles (which are shown by the broken line).

Using a load distribution graph, the vehicle can be marked with maximum weights at different positions along the deck. This will assist drivers to avoid overloading when positioning loads.



Plastic wrapping did not contain this load. The wrapping should not be relied upon as a restraint system unless certified by the consignor as suitable for the purpose.



Tilting the load inwards on the truck will not provide the required amount of sideways restraint. Additional restraint such as sides or gates is required. *(Photo courtesy John Brentnall).*



A few ropes will not restrain these wool bales.



Chains can be used to secure freight containers although in this case where two chains are used, check the anchor point strength first.



Loads in skips or tippers must be restrained if there is any possibility of the contents coming out.



Section G - Vehicle Structures



SECTION H

Load-Restraint Equipment

CONTENTS	
1	SYNTHETIC ROPE 225
2	WEBBING ASSEMBLIES 226
3	CHAIN ASSEMBLIES 227
4	WIRE ROPE AND ATTACHMENTS 227
5	STRAPPING 228
6	LASHING TENSIONERS AND CONNECTORS 229
7	INTER-LAYER PACKING 229
8	DUNNAGE, BLOCKING TIMBER, CHOCKS, AIR BAGS AND TYRES 230
8.1	Timber ----- 230
8.2	Dunnage ----- 230
8.3	Inflatable Dunnage (Air Bags) ----- 230
8.4	Tyres ----- 230

Section H - Load Restraint Equipment

This Section contains general design and selection information for load restraint equipment. It is intended for equipment manufacturers and suppliers, and vehicle owners and operators.

Load restraint equipment includes ropes, webbing, strapping, nets, chains and associated fittings, and attachments such as hooks, clamps, turnbuckles, tensioners and winches.

To avoid confusion with strength ratings assigned for lifting purposes, the term 'Lashing Capacity (LC)' is used to define load restraint capacity in preference to any of the following terms, viz. Maximum Working Load (MWL), Working Load Limit (WLL), and Rated Assembly Strength (RAS).

The lashing capacity of load restraint equipment is defined in the relevant Australian Standards.

Section B '*Arranging Loads on Vehicles*' and Section C, '*Restraining Loads on Vehicles*' contain the requirements which should be taken into account when considering the suitability, serviceability and use of load restraint equipment.

Section F '*Calculating Restraint Requirements*' contains the methods of selecting the load restraint equipment based on strength requirements.



1 SYNTHETIC ROPE

The selection of the appropriate rope for restraining loads is very important because there are a number of unsuitable ropes on the market, of unknown strength and quality that are not intended to be used as transport lashings.

Only fibre ropes that comply with *Australian Standard AS/NZS 4345 'Motor vehicles - Cargo Restraint Systems - Transport Fibre Rope'* (see Section J) should be used.

Sisal and manila ropes do not comply with the above requirements and should not be used for restraining loads on vehicles.

When assessing the serviceability of ropes in relation to the Australian Standard, they must be examined at about every metre of their length, both externally and between the strands.

If any of the following conditions exist, the rope must be replaced:

- (i) Ropes weakened by 10% or more of their original minimum breaking strength by wear or mechanical damage caused by excessive loading, knotting and bending.
- (ii) Ropes weakened by 10% or more of their original minimum breaking strength by exposure to chemicals, including acid and alkaline solutions and organic solvents. The chemicals weaken or soften the rope fibres, which can then be easily rubbed or plucked off.
- (iii) Ropes weakened by 10% or more of their original minimum breaking strength by exposure to high temperatures.
- (iv) Ropes weakened by 10% or more of their original minimum breaking strength by prolonged exposure to sunlight or ultraviolet light.

This damage can be recognised by the hairy appearance of the fibres.

Section H - Load Restraint Equipment

2 WEBBING ASSEMBLIES

Webbing assemblies with either attached or in-line ratchet winches should be manufactured to comply with *Australian Standard AS/NZS 4380, 'Motor vehicles - Cargo Restraint Systems - Transport Webbing & Components'* (see Section J).

When selecting webbing equipment it is important to ensure that the assembly components have an adequate lashing capacity for the application.

Webbing assemblies include load rated webbing material with specified stitching and sewing patterns, together with end fittings and tensioning devices.

When assessing the serviceability of webbing and attachments in relation to the Australian Standard, if any of the following conditions exist, the webbing or attachment must be replaced:

- (i) Webbing weakened by 10% or more of its original minimum breaking strength, by wear, damage, or stitching failure caused by excessive loading, knotting and bending.
- (ii) Webbing weakened by 10% or more of its original minimum breaking strength by exposure to chemicals, including acid and alkaline solutions and organic solvents.
- (iii) Webbing weakened by 10% or more of its original minimum breaking strength by exposure to high temperatures.
- (iv) Webbing weakened by 10% or more of its original minimum breaking strength by prolonged exposure to sunlight or ultraviolet light. This damage can be recognised by the hairy appearance of the fibres.
- (v) Webbing repaired in a manner not approved by the manufacturer.
- (vi) Any attachments (tensioner, hook and keeper, etc.) weakened by 10% or more, or, prevented from functioning by wear, damage or corrosion.

Note: Wear caused by chafing over rough surfaces causes a furry appearance on the webbing, and may lead to broken load-bearing fibres.

Damage caused by cuts and abrasions, resulting in broken load-bearing fibres is often localised to areas where the webbing contacts the load and coaming rails.



3 CHAIN ASSEMBLIES

The suitability of chain is determined by its size, strength, hardness and elongation. Chains manufactured from low strength materials are heavier, bulkier and more prone to damage and wear than higher tensile chain.

Chain assemblies should be manufactured to comply with *Australian Standard AS/NZS 4344, 'Motor vehicles - Cargo Restraint Systems – Transport Webbing & Components'* or *AS 2321 'Short-link Chain for Lifting Purposes'*, (see Section J).

Some chain tensioning systems, which can 'kickback' are dangerous and can cause injury to the operator. Alternative tensioners are available.

When assessing the serviceability of chains and attachments in relation to the Australian Standard, if any of the following conditions exist, the chain or attachment must be replaced:

- (i) Any link weakened by wear, damage or corrosion which reduces its diameter by more than 10%.
- (ii) Any bent, twisted, stretched or collapsed link.
- (iii) Any link repaired by welding (except when approved by the original manufacturer) or any unsuitable repair link or joined by a bolt or wire.
- (iv) A knot in any portion of the chain.
- (v) Any attachment (turnbuckle, load binder, grab hook, etc.) weakened or prevented from functioning by wear, damage or corrosion.

Chains should be joined using a joining link rated with a rating at least equal to the lashing capacity of the chain.

4 WIRE ROPE AND ATTACHMENTS

Steel wire rope with appropriate end fittings and tensioning winches can be used to effectively secure certain loads. Its greater elasticity makes it more suitable than chain for loads which settle during transport.

Australian Standard AS 3569 'Steel Wire Ropes' (also see Section J) specifies requirements for steel wire ropes for all purposes and also specifies materials, manufacture, marking, packing and test requirements.

Section H - Load Restraint Equipment

The manufacturers' rating of wire rope manufactured in accordance with *Australian Standard AS 3569 'Steel Wire Ropes'*, or other equivalent International Standard, should be no greater than one-third of its specified minimum breaking strength.

When assessing the serviceability of wire ropes and attachments in relation to the relevant Standards (see Section J), if any of the following conditions exist, the rope or attachment must be replaced:

- (i) Any rope length equivalent to 3 rope diameters containing more than 4 broken wires.
- (ii) Any rope length equivalent to 6 rope diameters containing more than 6 broken wires.
- (iii) Any rope length equivalent to 30 rope diameters containing more than 16 broken wires.
- (iv) Any rope where the diameter is reduced by more than 10% by abrasion.
- (v) Any rope which has been crushed or flattened by more than 15% of its nominal diameter.
- (vi) Any rope which is significantly notched or kinked.
- (vii) Any rope weakened by corrosion.
- (viii) Any attachment (shackle, thimble, turnbuckle, hook, etc.) weakened or prevented from functioning by wear, damage or corrosion.

5 STRAPPING

Strapping can be effectively used to restrain some loads. Steel strapping has a high-tensile strength and can be highly pre-tensioned using manual or power operated tensioners.

For example, 32 mm wide strapping with 0.8 mm minimum thickness has a minimum breaking strength of 2.32 tonnes and can be readily tensioned to 650 kg force. The typical joint strength of 1.6 tonnes is lower than the strapping strength and determines the breaking strength of the lashing assembly.

Loads with low frictional surfaces require high clamping forces for effective restraint. Steel strapping is therefore very suitable for unitising and lashing 'heavy and slippery' loads on container flats or bases.

The manufacturers' rating of a steel strapping assembly for lashing purposes should be no greater than half of its specified minimum breaking strength.

Further requirements for strapping are contained in *Australian Standard AS 2400.13 'Packaging - Tensional Strapping'* (see Section J).



6 LASHING TENSIONERS AND CONNECTORS

Webbing, chain and wire rope lashing assemblies all require mechanical tensioners and connectors, which should be manufactured and marked to recognised standards (see Section J). The marking will ensure traceability in case of product failure.

The lashing capacity of tensioners and connectors manufactured from steel should be no greater than half of their specified minimum breaking strength.

Tensioners and connectors should exhibit no permanent deformation and should be fully functional after being subjected to a force equal to 1.25 times their lashing capacity.

Tensioners should be designed so that the tension in the lashing cannot be inadvertently released and so that any 'kickback' which could cause injury to the operator is minimised.

Powered winches can be utilised for many applications. They can offer continuous automatic self-tensioning of the load during transport.

7 INTER-LAYER PACKING

Parts of a load can be separated by inter-layer packing. The inter-layer packing can take various forms including protective wrapping, cardboard, carpet, 'anti-slip' mats rubber matting, plywood and timber dunnage.

High friction inter-layer packing can increase friction between most surfaces and significantly reduce the number of tie-down lashings required to restrain a load.

Some inter-layer packing such as plastic wrapping, can be very slippery. This can significantly increase the number of tie-down lashings required.

Rubber matting can be natural or synthetic rubber plain sheet, or 'honey-combed' mat made from recycled tyres (anti-slip load mat). Anti-slip mat is very effective in increasing friction between loads and vehicles, especially when dry and hot. Conveyor belt material is generally not suitable for use as an anti-slip mat because it is made for wear resistance and can be too slippery.

The friction coefficient obtained with most loads on anti-slip rubber matting is usually more than 0.6, but can be lower than 0.45 with slippery loads such as some coated pipe.

8 DUNNAGE, BLOCKING TIMBER, CHOCKS, AIR BAGS AND TYRES

8.1 Timber

Timber used as dunnage, chocks, cradles or for blocking loads, should be carefully specified for each application. It should be strong enough to withstand being split or crushed by the load.

The timber selected should be relatively free of knots and splits.

Where steel strapping passes over sharp corners on the end of timber dunnage, these corners should be rounded or bevelled to prevent the timber being crushed. If the timber crushes the strapping will loosen.

8.2 Dunnage

The size selected should be based on the load and the maximum span between support points.

Square dunnage may be adequate for some purposes however rectangular dunnage is preferred, as long as the dunnage rests on a wide face (See Section B.4, page 46).

Where timber is used for dunnage, it is important to select the appropriate dunnage timber (the variety of hardwood/softwood, dressed/rough sawn) to maximise the friction between it, the load and the vehicle.

8.3 Inflatable Dunnage (Air Bags)

Inflatable air bags (disposable or reusable) are available in a wide variety of sizes and can be used to effectively restrain and separate loads contained in van bodies and shipping containers.

Air bags, also referred to as 'pneumatic load control systems' should be used strictly in accordance with the manufacturers' instructions.

8.4 Tyres

Rubber tyres can be used to separate contained loads. They can be used as wheel chocks on vehicles and mobile equipment restrained with tie-down lashings. Rubber tyres or parts of tyres can be used under heavy loads to increase friction for tie-down.



Typical damaged webbing straps (see Section H.2 for allowable wear).



The steel straps on this 15 tonne steel coil broke allowing the centre of the coil to spear outwards, causing the trailer to roll over.



This photo is a close-up of a tyre wedged between a large steel tipping body (see below) and the steel gooseneck of a trailer. The rubber tyre will act in a similar way to a rubber load mat and considerably reduces the amount of tie-down and/or additional direct restraint needed.





The plastic wrapping on the palletised cartons failed and allowed the cartons to dislodge. The ropes and cap tarpaulin are not suitable for restraining this load.



- 1 The red items are lugs and fittings for direct restraint. They are bolted or welded to the load and the carrying vehicle. Some are designed to weld on a flat surface and others on a 90 degree edge or corner.
- 2 The pink items are chain gauges. They are used to determine if a chain is stretched or worn. They measure the link length, diameter and internal width. They are normally brand specific. Check with the manufacturer of the chain you use.
- 3 The black items are rubber snubbing blocks. They act as shock absorbers for chains to stop them breaking under impact loads. They usually consist of a circle of six chain links set in rubber. Half a link protrudes from each end to connect the rest of the chain.



Section H - Load Restraint Equipment

SECTION I

How to Certify a Load Restraint System

CONTENTS	
1 WHO SHOULD DO THE DESIGN AND CHECKING?	236
2 SUGGESTED METHODS OF TESTING A LOAD RESTRAINT SYSTEM	236
3 REPORTING	238
4 RECORDS	239
5 OTHER	239
6 LOADING AND LOAD RESTRAINT PROCEDURES	239

This section contains general information on the selection of a competent person to design and/or certify a load restraint system, on the methods of testing and on the production of appropriate documentation. The purpose of certifying a load restraint system is to ensure that it meets the load restraint Performance Standards.

Documentation of loading and load restraint procedures will enable the consignor of goods, the person in charge of loading, the vehicle owner, the driver and enforcement personnel to verify whether a load complies with loading Regulations.

1 WHO SHOULD DO THE DESIGN AND CHECKING?

Only a person with appropriate skills and experience should assess and certify a load restraint system. Normally a mechanical engineer with full membership of the Institute of Engineers Australia should be chosen. The person should have an understanding of vehicle design and detailed knowledge of load restraint issues. A person with these qualifications and background should be accepted as an 'expert witness' to represent a client in Court.

2 SUGGESTED METHODS OF TESTING A LOAD RESTRAINT SYSTEM

Consider whether the type of vehicle(s) is appropriate to carry the load by consulting with the manufacturer if necessary.

Consider whether the lashing(s) used is appropriate for the load and the type of operating environment. For instance, will the elasticity of a lashing be an advantage or disadvantage?

Care should be taken in testing of load restraint systems because of the possibility of the sudden release of stored energy in the load, lashings or testing apparatus, if an unexpected failure occurs.

2.1 Tie-down System

Where tie-down is used and the system is meant for a range of vehicles or for use in a vehicle fleet, ensure that all vehicles will perform the same when loaded having regard to the friction coefficient over the load space and the restraint attachment points. For instance, steel, aluminum and timber decks might be fitted to different vehicles in a fleet.

Where there could be differences of friction coefficient or weight due to packaging variances or component specifications, ensure that the test load chosen is the worst case. Any report or procedure should accurately describe the product or the load type.

If the load type is in layers or stacked, the performance of the stacking method in the pack must be assessed as well as the performance of the load as a whole.

Friction testing should be performed on the unsecured load by either:

Tilting it until the load slips, or;

Pushing or pulling the load until the load slips.

All tie-down systems where lashings are tensioned by load shift (Section F.3.7 page 198), should be physically tested to evaluate the load restraint forces and the behaviour of the load.

The initial physical tests should be vehicle braking tests.

Where braking tests cannot replicate 0.8 'g' deceleration of the vehicle, the actual forces must be calculated using the results of the actual tests as a basis for the certification.

2.2 Direct Restraint System (Attachment, Blocking, Containment)

Direct load restraint systems can be assessed by calculation provided the calculations take into account the true operating conditions and methods of attachment.

The integrity of a pack which is strapped or wrapped, or uses tie-down to unitise the individual items, should be checked by restraining the base and tilting it to the equivalent angles of the Performance Standards (also see Section F.5 page 200).

All direct restraint systems, where movement is permitted (see Section F.1, page 186) Performance Standards, should be physically tested.

Where containment systems are used without any tie-down, the load(s) should be placed on rollers or similar for testing, to negate the effect of friction under and between parts of the load. In a containment system where there is no tie-down, it must be assumed friction is zero as the load can leave the deck over bumps.

As coaming rails are not high enough to guarantee horizontal restraint of a load that is not tied down, care must be taken to ensure they are not in contact with the load during testing.

The following are several basic methods of testing direct restraint systems:

Horizontal Force - Forces could be applied to the restraint system to test its capacity, by pushing against it with objects simulating the loads to be carried. The force can be applied through mechanical, hydraulic or pneumatic (cylinder or air-bag) methods.

Vertical Force - The vehicle or body could be tipped on its side and half (0.5 'g') the load placed on top of the side restraint system or tipped on end and 80% (0.8 'g') of the load placed on top of the front restraint system.

Tilting - The vehicle could be tilted sideways at 30° or endways at 53° and the load placed on rollers or vibrated to simulate road shocks and vibration.

The following are ways of testing each type of load for sideways restraint:

(i) Stable and Unstable Single Loads

Vehicle horizontal, load on rollers pushed against side restraint structure.

Vehicle tilted at 30°, load on rollers.

(ii) Stacked Loads

Vehicle horizontal, load stacked using slippery separators, load pushed evenly against side restraint structure, using appropriate force distribution system (hydraulics, pneumatics, air bladder etc).

Vehicle on side, half load stacked on side restraint structure, load vibrated.

Vehicle tilted at 30°, load stacked using slippery separators, load vibrated.

(iii) Loose Bulk Loads

Vehicle horizontal, load pushed evenly against side restraint structure, using appropriate force distribution system (rigid longitudinal panel, air bladder etc against load or side restraint structure).

Vehicle on side, half load stacked on side restraint structure, load vibrated.

Vehicle tilted at 30°, load vibrated.

Similar test methods can be used for forward and rearward restraint with appropriate 0.8 'g' and 0.5 'g' force simulation and 53° and 30° tilt angles.

The deflection of the restraint system will limit the capacity for restraining many loads. In the absence of any test data or guidelines on allowable load shift for the different types of load, the maximum sideways deflection of the restraint system including side curtains should be limited to 100 mm.

3 REPORTING

A report on a load restraint system should include:

- (i) A description of the load type and any unitising system used.
- (ii) A description of the restraint method used including the type of lashing, the size (e.g. 50 mm wide, 8 mm diameter etc.) and any identifying features.
- (iii) Where the system uses tie-down, the type of friction surfaces or friction material the system has been designed to use and the design tension in the lashing(s).
- (iv) The existence and specification of any interlayer packing.
- (v) The method of stacking the load.

- (vi) If the system is a direct method, the location of the attachment points should be accurately described and where appropriate, accurate dimensions given.
- (vii) A drawing showing the load type and the restraint system should be prepared. This should be used by the vehicle driver to ensure that the load is restrained in the same manner as tested.
- (viii) A statement describing any maintenance schedule, safety precautions, tensioning or retensioning procedures and other special requirements.
- (ix) Relevant particulars of the person certifying the load restraint system.

4 RECORDS

Copies of all calculations, test results and equipment data should be retained for future reference by all relevant parties.

5 OTHER

The registration authorities in each State and Territory usually have a list of qualified persons who can carry out engineering work. Ensure that any person chosen is qualified and has the experience to do the work.

Persons designing a load restraint system should also contact the authorities in each State or Territory (Section J.4 page 253) to check if any special requirements apply which are not in this guide including dangerous goods and occupational health and safety.

6 LOADING AND LOAD RESTRAINT PROCEDURES

A loading and load restraint procedure document should be prepared for use by consignors, loading staff, vehicle owners, operators, drivers, enforcement personnel and unloading staff as appropriate.

The document should contain all information necessary to enable a vehicle to be loaded and the load restrained to meet the Regulation performance standards.



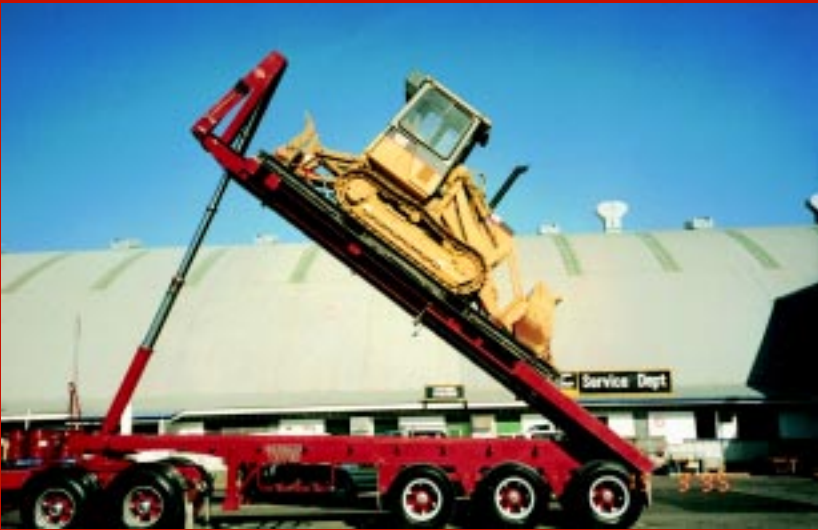
Tilt testing a cotton bale packing arrangement.



Testing the friction by tilting the load and measuring the angle at the point it just slides. The test is for both the friction between the bales and the bales and the deck.



Another method for testing friction by first weighing the load and then measuring the force needed to just slide it on the deck of the truck. The forklift tractor provides the pulling force and a load cell fitted to a chain between the tractor and hay bale reads the pulling force.



Test of a restraint system for a tracked loader. (Photo courtesy Loadsafe Australia).



A good attempt, but these chains will not hold this 26 tonne roll of steel cable. A better system, which is also easier, would be to use a properly designed cradle (see Section G.7, page 214).



This photo is a view of the back of the driver's cabin of a prime mover. It was damaged by a tractor that was being carried on a low loader. When the prime mover braked, the tractor rolled forward, up and over the 'goose neck' onto the cabin.



If a load is not restrained in the vertical direction to 20% of its weight, it must be assumed that it can move. Friction cannot be taken into account. This photo shows a test of a gate as part of a containment system. The bricks are on rollers so their full force is applied to the gate. *(Photo courtesy Loadsafe Australia).*



This car hit a hay bale that fell off a truck. Note that the roof has been bent by the impact. *(Photo courtesy Border Mail).*

Section I - How to Certify a Load Restraint System

SECTION J**Appendices**

CONTENTS	
1 GLOSSARY	246
2 LIST OF RELEVANT STANDARDS	250
3 LIST OF RELEVANT PUBLICATIONS	251
4 COMMONWEALTH, STATE AND TERRITORY TRANSPORT REGULATORY AUTHORITIES	253
5 COMPETENT AUTHORITIES FOR ROAD TRANSPORT OF DANGEROUS GOODS	254

Section J - Appendices

1 GLOSSARY

air bag	An inflatable barrier placed between a section of the load and the vehicle to stop any movement of the load. It can be disposable or reusable.
aggregate trailer mass	The total mass of a trailer carrying the maximum load as specified by the trailer manufacturer (also called ATM). It includes the mass on the drawbar as well as the mass on the axles.
anchor point	Fitting or attachment on a vehicle or load to secure lashings.
baffles	Barriers fitted crosswise and lengthwise inside tanks to limit surging of fluids (or loads which behave like fluids) during acceleration, braking and cornering.
baulking	see blocking
billet	A solid length of raw material normally steel, bronze or aluminium.
bolster	Rigid support base commonly used to support logs on jinkers.
blocking	Material, usually timber, placed between the load and the vehicle structure, to prevent movement of the load (also see dunnage .)
cap tarp	A smaller tarpaulin fitted over the top of a load and only part of the sides.
centre of mass	The centre of balance of a load (also called 'centre of gravity').
centroid	The centre point of the cross-section of the tank.
cheater bar	Usually a length of pipe placed over the operating lever of a dog so as to extend its length. (The use of these extensions is not approved by any manufacturer and can be dangerous).
chocks	Usually wedge shaped blocks used to prevent movement of the load (also see wedges).
claw hook	A chain hook in the shape of a claw.
coaming	A frame border around the outside of a vehicle's loading deck.

contained load	A load prevented from dislodging from the vehicle by the vehicle structure, gates, sides, racks, headboards, stanchions etc.) or other parts of the load.
corner protectors	Material used to protect lashings and the exposed edges of loads and vehicles, and to allow lashings to slide freely when being tensioned.
cradle	A frame shaped to support a rounded object.
cribbing	A method of supporting a load on a stable column of packing of uniform thickness, stacked in pairs, with alternate layers at 90 degrees to one another.
cross-member	A support placed crosswise below the loading deck.
deck	The load carrying surface of a vehicle.
dog	A chain tensioner incorporating an over-centre locking action with a fixed or pivoting lever.
dunnage	Packing placed either between items of a load or between the base of a load and the surface of the vehicle's loading deck (also see blocking). (The word 'dunnage' is derived from the era of sailing ships where wood packing was used to raise the cargo above the bilge water in the hold.)
flush deck	A flat loading deck without a raised coaming .
gates	Permanent or removable vertical frames used at the front, sides and rear of a vehicle's loading deck to contain its load. The front gate is usually called a loading rack or load rack.
gluts	see dunnage .
Gross Combination Mass	The value specified by the manufacturer of a vehicle as being the sum of its gross vehicle mass plus the maximum loaded mass of any trailer (or motor vehicle) that it can tow in combination (also called GCM).
Gross Trailer Mass	The mass on the axle(s) of a trailer when fully loaded (also called GTM).
Gross Vehicle Mass	The maximum mass of a motor vehicle when loaded, as specified by its manufacturer (also called GVM).
headboard	Usually a permanent vertical frame used at the front of a vehicle's loading deck to contain its load (also known as a bulkhead).

Section J - Appendices

hungry board	A rail or framework (permanent or removable) added to the sides of a truck body to increase load capacity.
lashings	Fastening devices, chains, cables, ropes or webbing used to restrain loads.
lashing capacity (LC)	The maximum force (in kilograms) that a lashing system is designed to sustain in use.
load binder	A device used for tensioning a lashing. (see truck winch or dog).
load capacity	The difference between the GVM or GTM of a vehicle and its tare mass .
load mat	A sheet of material used to increase friction and protect the load (also called anti-slip mat or friction mat).
loading rack	see gates .
pallet	A portable platform or tray onto which loads are placed for mechanical handling.
pantechnicon	A vehicle with a body enclosed by solid rigid sides and roof.
pawl	A lever or lock which prevents reverse rotation on a winch.
pockets	Housings or slots fixed to the vehicle to locate gates, stakes or loading pegs.
pre-tension	The initial tension in a lashing after tensioning.
rope single hitch	Refer Figure C.27
rope double hitch	Refer Figure C.27
rope hooks	Attachments fixed to the surrounds of the loading deck for securing of tarpaulin and tie-down ropes.
rope rail	see tie rail
shackle	A metal coupling link closed by a bolt which can be used for attaching chain fittings.
shoring bar	Adjustable metal beam used to restrain or segregate sections of load (also known as a shoring pole).
sling	A length of hemp-core rope, webbing or steel-wire rope with eyes formed at each end.

Section J - Appendices

spreader	A transverse spar or frame used to support tarpaulins and side gates.
stake	An upright metal rod or section (also called a peg or pin).
stanchion	A large upright fixed to the side of a vehicle for sideways restraint.
stillage	A metal structure for containing individual items of load.
strut	A rigid member which can support loads in the direction of its length.
tare mass	The unladen mass of a motor vehicle or trailer.
tarpaulin (tarp)	A waterproof sheet used to cover and protect goods from the weather.
tensioner	A device used to tighten a lashing (winch, dog , hand ratchet etc).
tie down	Tie down is when the load is prevented from moving by friction only.
tie rail	A round rail which skirts the perimeter of the loading deck below the coaming rail.
truck winch	A device used for tensioning a lashing which is normally placed under the coaming rail and may be fixed in position using the tie-rail or slide on a track (also see winch).
turnbuckle	A tensioner consisting of a threaded sleeve and two mating threaded ends.
twist lock	A locking device with a rotating head which normally engages a corner casting on the load.
wedge	A piece of rigid material, thick at one end and tapering to a thinner edge at the other (also see chocks).
winch	A device for tensioning lashings via a rotating spool.

Section J - Appendices

2 LIST OF RELEVANT STANDARDS

A list of all standards applicable to the transport of dangerous goods can be found in the *Australian Code for the Transport of Dangerous Goods (Road and Rail)*.

Information on how to obtain the current versions of the following standards may be available from:

**National Sales Centre
STANDARDS AUSTRALIA** www.standards.com.au
GPO Box 5420
Sydney NSW 2001

Phone (from anywhere in Australia): **1300 654 646**

Fax (from anywhere in Australia): 1300 654 949

or from the nearest office of Standards Australia

Cargo Restraint Systems - Motor vehicles - Cargo Restraint Systems - Transport Chain and Components	AS/NZS 4344
- Motor vehicles - Cargo Restraint Systems - Transport Webbing and Components	AS/NZS 4380
- Motor vehicles - Cargo Restraint Systems - Transport Fibre Rope	AS/NZS 4345
Motor Vehicles - Motor vehicles - Anchorages and anchor points for securing internal cargo	AS/NZS 4384
Fibre Ropes	AS 4142 (Parts 1 & 2)
Short-link Chain for Lifting Purposes	AS 2321
Steel Wire Ropes	AS 3569
Shackles	AS 2741
Shank Hooks and Large-eye Hooks - Maximum 25t	AS 3777
Thimbles for Wire Rope	AS 1138
Packaging - Tensional Strapping	AS 2400.13
Load Anchorage Points for Heavy Vehicles	NZS 5444
Pressure Vessels	AS 1210
Storage & Handling of LP Gas	AS/NZS 1596
Anhydrous Ammonia - Storage and Handling	AS 2022
Road Tank Vehicles for Dangerous Goods - General Requirements	AS 2809 (Parts 1-6)
Freight Containers	AS/NZS 3711 (Parts 1-9)
Load Restraint Guide	

Motor Vehicles - Cargo Barriers for Occupant Protection	AS/NZS 4034 (Parts 1 & 2)
Lashing and Securing Arrangements on Road Vehicles for Sea Transportation on Ro/Ro Ships	ISO 9367 (Parts 1 & 2)
Securing of Cargo on Road Vehicles, Lashing Points on Commercial Vehicles for Transportation, Minimum Requirements and Testing	DIN EN 12640-2001

AS	is Australian Standard
NZS	is New Zealand Standard
ISO	is International Organisation for Standardisation
DIN	is German Institute for Standardisation

3 LIST OF RELEVANT LEGISLATION AND PUBLICATIONS

Information on the availability and contact details for the following national model legislation/publications or their updates may be obtained from the NTC website: www.ntc.gov.au However, please check local State and Territory laws when establishing legal obligations as jurisdictions may have varied the national laws when implementing them.

Australian Code for the Transport of Dangerous Goods by Road and Rail
Australian Code for the Transport of Explosives by Road and Rail

These Codes are available from:

Canprint Information Services
PO Box 7456
CANBERRA MC ACT 2610
Tel: 1300 889 873
Fax: (02) 6293 8333

Road Transport Reform (Vehicles and Traffic) Act 1993
Road Transport Reform (Mass and Loading) Regulations 1995
Road Transport Reform (Oversize and Overmass Vehicles) Regulations 1995
Australian Vehicle Standards Rules 1999
The Australian Truck Drivers Manual

Section J - Appendices

Other publications might be available from State and Territory vehicle registration/regulatory authorities, trucking, motoring and industry associations such as:

A Guide to Restraining Steel: VicRoads December 1998

A Guide to Restraining Concrete Panels: VicRoads August 1999

A Guide to Restraining Rolls and Reels: VicRoads August 1999

A Guide to Restraining Bales: VicRoads September 1999

A Guide to Restraining Loads on Light Vehicles: VicRoads November 1999

A Guide to Restraining Concrete Pipes: VicRoads January 2000

A Guide to Restraining Logs and Timber: VicRoads November 2003

Cotton Restraint Guide 1999: Cotton Australia

Tel. (02) 9360 8500

Website: www.cottonaustralia.com.au

A Guide to Dogging 1994, Catalogue No 2: WorkCover NSW

Safety in Forest Harvesting Operations Code of Practice 2002,

Catalogue No 1005: WorkCover NSW

Tel: 1300 799 003

National Code of Practice, Heavy Vehicle Modifications, Vehicle Standards

Bulletin No 6: Commonwealth Department of Transport and Regional Services

Tel: (02) 6274 7111

4 COMMONWEALTH, STATE AND TERRITORY TRANSPORT REGULATORY AUTHORITIES

Commonwealth or National bodies:

Commonwealth Department of
Transport and Regional Services
Transport Regulation Division
GPO Box 594
CANBERRA ACT 2601
Tel: (02) 6274 7111 Fax: (02) 6274 7922
Website: www.dotars.gov.au

National Transport Commission
Level 15, 628 Bourke Street
MELBOURNE VIC 3000 AUSTRALIA
Tel: (03) 9236 5000 Fax: (03) 9642 8922
Email: ntc@ntc.gov.au
Website: www.ntc.gov.au

State & Territory bodies:

New South Wales:

NSW Roads and Traffic Authority
PO Box K198
HAYMARKET NSW 1238
Tel: 1300 137 302 Fax: (02) 9843 3821
Email: tech-enq@rta.nsw.gov.au
Website: www.rta.nsw.gov.au

Australian Capital Territory:

Department of Urban Services
Road User Services
Vehicle Inspection & Technical Unit
PO Box 582, Dickson ACT 2062
Tel: (02) 6207 7236 Fax: (02) 6207 6561
Website: www.act.gov.au

Queensland:

Queensland Transport
PO Box 673
FORTITUDE VALLEY QLD 4006
Tel: (07) 3253 4452 Fax: (07) 3253 4607
Email: fred.w.guillessen@transport.qld.gov.au
Website: www.transport.qld.gov.au

Victoria:

VicRoads
60 Denmark St
KEW VIC 3105
Tel: (03) 9854 2666 Fax: (03) 9853 0390
Website: www.vicroads.vic.gov.au

South Australia:

Transport SA
PO Box 1
WALKERVILLE SA 5081
Tel: 1300 656 243
Email: enquiries@transport.sa.gov.au
Website: www.transport.sa.gov.au

Northern Territory:

Department of Infrastructure, Planning &
Environment
Vehicle Compliance
GPO Box 530
DARWIN NT 0801
Tel: (08) 8999 3163 Fax: (08) 8999 3101
Website: www.nt.gov.au/ipe/dtw/

Western Australia:

Department for Planning & Infrastructure
Vehicle Safety
21 Murray Road, South
WELSHPOOL WA 6106
Tel: (08) 9216 8000 Fax: (08) 9351 1699
Website: www.dpi.wa.gov.au

Tasmania:

Department of Infrastructure, Energy & Resources
Inquiry Service
GPO Box 1002K
Hobart TAS 7001
Tel: (03) 6233 5201 Fax: (03) 6233 5210
Website: www.transport.tas.gov.au

Section J - Appendices

5 COMPETENT AUTHORITIES FOR ROAD TRANSPORT OF DANGEROUS GOODS

Information on the transport of Dangerous Goods and details of the Competent Authorities can be obtained from the website: http://www.dotrs.gov.au/transreg/str_dgoodsum.htm

State & Territory bodies:

New South Wales:

(Labelling & Classification)
State Coordinator
Compliance Coordination Team
WorkCover NSW
Level 3, 92-100 Donnison Street
GOSFORD NSW 2250
Tel: (02) 4321 5191 Fax: (02) 4325 4736

(All other matters)
Manager, Dangerous Goods
Department of Environment and Conservation
59-61 Goulburn Street
Sydney NSW 2000
Tel: (02) 9995 5412 Fax: (02) 9995 5918

Queensland:

Director-General
Queensland Transport
Dangerous Goods Unit
PO Box 673
FORTITUDE VALLEY QLD 4006
Tel: (07) 3253 4035 Fax: (07) 3253 4453

South Australia:

Manager, Dangerous Goods Workplace Services
Department of Administrative and Information
Services
GPO Box 465
ADELAIDE SA 5001
Tel: (08) 8303 0435 Fax: (08) 8303 0444

Western Australia:

Chief Inspector Dangerous Goods Safety
Department of Industry and Resources
100 Plain Street
EAST PERTH WA 6004
Tel: (08) 9222 3595 Fax: (08) 9325 2280

Australian Capital Territory:

Chief Inspector of Dangerous Goods
Dangerous Goods Unit
ACT WorkCover
PO Box 224
CIVIC SQUARE ACT 2608
Tel: (02) 6207 6355 Fax: (02) 6207 7249

Victoria:

The Manager, Dangerous Goods Unit
Victorian WorkCover Authority
Level 22, 222 Exhibition Street
MELBOURNE VIC 3000
Tel: (03) 9641 1551 Fax: (03) 9641 1552

Northern Territory:

Chief Inspector of Dangerous Goods
Department of Management and Business
PO Box 4160
DARWIN NT 0801
Tel: (08) 8999 5010 Fax: (08) 8999 5141

Tasmania:

The Delegate of the Competent Authority
Department of Infrastructure, Energy and
Resources
Workplace Standards Tasmania
PO Box 56
ROSNY PARK TASMANIA 7018
Tel: local calls 1300 366 322
Tel: Interstate calls (03) 6233 7657
Fax: (03) 6233 8338



(See below).



Concrete panels moved forward under braking in city traffic killing the driver.
A \$160,000 fine was awarded against the company that owned the truck.



This load of watermelons would have been better restrained by containing it, rather than trying to tie it down.




Skips and bins must be restrained on the vehicle. Care must be taken when carrying high centre of mass loads to avoid roll-over.

SECTION K

Tables

CONTENTS			
1	C.3	MAXIMUM WEIGHT RESTRAINED BY ONE LASHING	258
2	C.4	TYPICAL LASHING CAPACITY	259
3	F.2	AVERAGE PRE-TENSION	260
4	F.3	MAXIMUM WEIGHT EACH 10 OR 12 mm ROPE CAN RESTRAIN (USING SINGLE HITCH)	261
5	F.4	MAXIMUM WEIGHT EACH 10 OR 12 mm ROPE CAN RESTRAIN (USING DOUBLE HITCH)	262
6	F.5	MAXIMUM WEIGHT EACH 50 mm WEBBING STRAP CAN RESTRAIN	263
7	F.6	MAXIMUM WEIGHT EACH 8 mm CHAIN CAN RESTRAIN	264
8	F.7	MINIMUM LASHING CAPACITY – DIRECT RESTRAINT FORWARDS (0.8W) USING TWO CHAINS	265
9	F.8	MINIMUM LASHING CAPACITY – DIRECT RESTRAINT SIDEWAYS OR REARWARDS (0.5W) USING TWO CHAINS	266

1 Table C.3

MAXIMUM WEIGHT RESTRAINED BY ONE LASHING (with no load shift)						
FRONT OF LOAD BLOCKED?	NO		YES			
HOW MUCH FRICTION?	MEDIUM <small>(Smooth Steel on Timber) $\mu = 0.4$</small>	HIGH <small>(Rubber Load Mat) $\mu = 0.6$</small>	MEDIUM <small>(Smooth Steel on Timber) $\mu = 0.4$</small>	HIGH <small>(Rubber Load Mat) $\mu = 0.6$</small>		
 <p>$H+L = 0.85$ or more</p>	<p>Lashing angle 60° or more to horizontal</p>					
ROPE - Single Hitch <small>(50 kg average tension)</small>	85 kg	255 kg	340 kg	425 kg		
ROPE - Double Hitch <small>(100 kg average tension)</small>	170 kg	510 kg	680 kg	850 kg		
WEBBING STRAP <small>(300 kg average tension)</small>	510 kg	1530 kg	2040 kg	2550 kg		
CHAIN <small>(750 kg average tension)</small>	1275 kg	3825 kg	5100 kg	6375 kg		

(See Figure C.27 on page 81 for single and double hitch)

2 Table C.4

TYPICAL LASHING CAPACITY		
Lashing	Lashing Capacity (LC)	
12 mm synthetic (silver) rope	300 kg	
25 mm webbing	250 kg	
35 mm webbing	1.0 tonne	
50 mm webbing	2.0 tonnes	
chain*	with claw hooks or 'winged' grab hooks	with grab hooks or edge contact
6 mm transport chain	2.3 tonnes	1.7 tonnes
7.3 mm transport chain	3.0 tonnes	2.3 tonnes
8 mm transport chain	4.0 tonnes	3.0 tonnes
10 mm transport chain	6.0 tonnes	4.5 tonnes
13 mm transport chain	9.0 tonnes	6.7 tonnes
13 mm Grade 'T' chain **	10.0 tonnes	7.5 tonnes
16 mm Grade 'T' chain **	16.0 tonnes	12.0 tonnes

* Note: Different hooks have different lashing capacities and chains that pass over sharp edges such as coaming rails have reduced lashing capacity (see Section C 6.5).

** Note: Grade 'T' lifting chain is also referred to as Grade 80 or 'Herc-alloy'.

3 Table F.2





AVERAGE PRE-TENSION			
Lashing	Size	Tensioner	Pre-tension
Rope	10 mm & 12 mm	Single Hitch	50 kg
		Double Hitch	100 kg
Webbing Strap	25 mm	Hand Ratchet	100 kg
	35 mm	Hand Ratchet	250 kg
	50 mm	Truck Winch	300 kg
	50 mm	Hand Ratchet (push up)	300 kg
	50 mm	Hand Ratchet (pull down)	600 kg
Chain	7 mm & above	Dog Turnbuckle	750 kg 1000 kg

(See Figure C.27 on page 81 for single and double hitch)

Note 1: some 75 and 100 mm strap tensioners may not achieve 300 kg average pre-tension even though their lashing capacity is greater. Check their rating with the manufacturer.

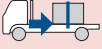
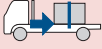

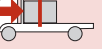
Note 2: the pre-tension achieved with chain tensioners is approximately the same for 7 mm, 8 mm, 10 mm and 13 mm chains.

4 Table F.3

MAXIMUM WEIGHT EACH 10 OR 12 mm ROPE CAN RESTRAIN (USING SINGLE HITCH)					
FRONT OF LOAD BLOCKED?		NO		YES	
HOW MUCH FRICTION?		MEDIUM $\mu = 0.4$ (Smooth Steel on Timber)	HIGH $\mu = 0.6$ (Rubber Load Mat)	MEDIUM $\mu = 0.4$ (Smooth Steel on Timber)	HIGH $\mu = 0.6$ (Rubber Load Mat)
Minimum average rope tension 50 kg.					
ROPE ANGLE	ANGLE EFFECT (E)				
90°	1.0	100 kg	300 kg	400 kg	500 kg
approx. 60° to 90°	0.85 to 1.0	85 kg	255 kg	340 kg	425 kg
approx. 45° to 60°	0.70 to 0.84	70 kg	210 kg	280 kg	350 kg
approx. 30° to 45°	0.50 to 0.69	50 kg	150 kg	200 kg	250 kg
approx. 15° to 30°	0.25 to 0.49	25 kg	75 kg	100 kg	125 kg

(See Figure C.27 on page 81 for single and double hitch)

5 Table F.4

MAXIMUM WEIGHT EACH 10 OR 12 mm ROPE CAN RESTRAIN (USING DOUBLE HITCH)					
FRONT OF LOAD BLOCKED?		NO		YES	
HOW MUCH FRICTION?		MEDIUM $\mu = 0.4$ (Smooth Steel on Timber)	HIGH $\mu = 0.6$ (Rubber Load Mat)	MEDIUM $\mu = 0.4$ (Smooth Steel on Timber)	HIGH $\mu = 0.6$ (Rubber Load Mat)
Minimum average rope tension 100 kg.					
ROPE ANGLE	ANGLE EFFECT (E)				
90°	1.0	200 kg	600 kg	800 kg	1000 kg
approx. 60° to 90°	0.85 to 1.0	170 kg	510 kg	680 kg	850 kg
approx. 45° to 60°	0.70 to 0.84	140 kg	420 kg	560 kg	700 kg
approx. 30° to 45°	0.50 to 0.69	100 kg	300 kg	400 kg	500 kg
approx. 15° to 30°	0.25 to 0.49	50 kg	150 kg	200 kg	250 kg

(See Figure C.27 on page 81 for single and double hitch)

6 Table F.5

MAXIMUM WEIGHT EACH 50 mm WEBBING STRAP CAN RESTRAIN					
FRONT OF LOAD BLOCKED?		NO		YES	
HOW MUCH FRICTION?		MEDIUM $\mu = 0.4$ (Smooth Steel on Timber)	HIGH $\mu = 0.6$ (Rubber Load Mat)	MEDIUM $\mu = 0.4$ (Smooth Steel on Timber)	HIGH $\mu = 0.6$ (Rubber Load Mat)
Minimum average strap tension 300 kg.					
STRAP ANGLE	ANGLE EFFECT (E)				
90°	1.0	600 kg	1800 kg	2400 kg	3000 kg
approx. 60° to 90°	0.85 to 1.0	510 kg	1530 kg	2040 kg	2550 kg
approx. 45° to 60°	0.70 to 0.84	420 kg	1260 kg	1680 kg	2100 kg
approx. 30° to 45°	0.50 to 0.69	300 kg	900 kg	1200 kg	1500 kg
approx. 15° to 30°	0.25 to 0.49	150 kg	450 kg	600 kg	750 kg

7 Table F.6

MAXIMUM WEIGHT EACH 8 mm CHAIN CAN RESTRAIN					
FRONT OF LOAD BLOCKED?		NO		YES	
HOW MUCH FRICTION?		MEDIUM $\mu = 0.4$ (Smooth Steel on Timber)	HIGH $\mu = 0.6$ (Rubber Load Mat)	MEDIUM $\mu = 0.4$ (Smooth Steel on Timber)	HIGH $\mu = 0.6$ (Rubber Load Mat)
Minimum average chain tension 750 kg.					
CHAIN ANGLE	ANGLE EFFECT (E)				
90°	1.0	1500 kg	4500kg	6000 kg	7500 kg
approx. 60° to 90°	0.85 to 1.0	1275 kg	3825 kg	5100 kg	6375 kg
approx. 45° to 60°	0.70 to 0.84	1050 kg	3150 kg	4200 kg	5250 kg
approx. 30° to 45°	0.50 to 0.69	750 kg	2250 kg	3000 kg	3750 kg
approx. 15° to 30°	0.25 to 0.49	375 kg	1125 kg	1500 kg	1875 kg

8 Table F.7

MINIMUM LASHING CAPACITY - DIRECT RESTRAINT FORWARDS (0.8W) USING TWO CHAINS			
Mass of Load (kilograms)	Minimum Lashing Capacity		
	E = 0.85 to 1.0	E = 0.70 to 0.84	E = 0.50 to 0.69
100	48	58	80
200	95	115	160
300	142	172	240
400	189	229	320
500	236	286	400
750	353	429	600
1000	471	572	800
1500	706	958	1200
2000	942	1143	1600
(tonnes)			
3	1.5	1.8	2.4
4	1.9	2.3	3.2
5	2.4	2.9	4.0
6	2.9	3.5	4.8
7	3.3	4.0	5.6
8	3.8	4.6	6.4
9	4.3	5.2	7.2
10	4.8	5.8	8.0
11	5.2	6.3	8.8
12	5.7	6.9	9.6
13	6.2	7.5	10.4
14	6.6	8.0	11.2
15	7.1	8.6	12.0
16	7.6	9.2	12.8
17	8.0	9.8	13.6
18	8.5	10.3	14.4
19	9.0	10.9	15.2
20	9.5	11.5	16.0
21	9.9	12.0	16.8
22	10.4	12.6	17.6
23	10.9	13.2	18.4
24	11.3	13.8	19.2
25	11.8	14.3	20.0
26	12.3	14.9	20.8
27	12.8	15.5	21.6
28	13.2	16.0	22.4
29	13.7	16.6	23.2
30	14.2	17.2	24.0

9 Table F.8

MINIMUM LASHING CAPACITY - DIRECT RESTRAINT SIDEWAYS OR REARWARDS (0.5W) USING TWO CHAINS			
Mass of Load (kilograms)	Minimum Lashing Capacity		
	E = 0.85 to 1.0	E = 0.70 to 0.84	E = 0.50 to 0.69
100	30	36	50
200	59	72	100
300	89	108	150
400	118	143	200
500	148	179	250
750	221	268	375
1000	295	358	500
1500	442	536	750
2000	589	715	1000
(tonnes)			
3	0.9	1.1	1.5
4	1.2	1.5	2.0
5	1.5	1.8	2.5
6	1.8	2.2	3.0
7	2.1	2.5	3.5
8	2.4	2.9	4.0
9	2.7	3.3	4.5
10	3.0	3.6	5.0
11	3.3	4.0	5.5
12	3.6	4.3	6.0
13	3.9	4.7	6.5
14	4.2	5.0	7.0
15	4.5	5.4	7.5
16	4.8	5.8	8.0
17	5.0	6.1	8.5
18	5.3	6.5	9.0
19	5.6	6.8	9.5
20	5.9	7.2	10.0
21	6.2	7.5	10.5
22	6.5	7.9	11.0
23	6.8	8.3	11.5
24	7.1	8.6	12.0
25	7.4	9.0	12.5
26	7.7	9.3	13.0
27	8.0	9.7	13.5
28	8.3	10.0	14.0
29	8.6	10.4	14.5
30	8.9	10.8	15.0



This driver and passenger used a good load restraint method on themselves by wearing a seat belt. They were able to walk away from the truck after it rolled over at speed on a country road. The same forces that move the load and the truck are also applied to you. Seat belts save lives.

The security of your load,
your life and the life of others
relies on proper
load restraint

